

Super-mini Signal Conditioners Mini-M Series

INSTALLATION BASE

Functions & Features

- Receiving up to 16 Mini-M modules
- Enabling interfacing analog I/Os to various network bus in combination with the 61-UNIT series communication modules
- Power supplied through printed wiring on the base

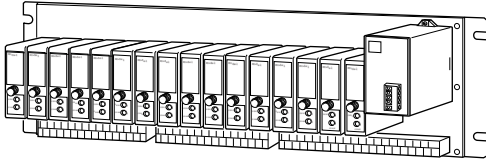

MODEL: M2BS2-[1][2]-[3]

ORDERING INFORMATION

- Code number: M2BS2-[1][2]-[3]
- Specify a code from below for each [1] through [3].
(e.g. M2BS2-161-K)

[1] CAPACITY

- 04: 4 positions
- 08: 8 positions
- 16: 16 positions

[2] I/O TYPE

- 1: Input (Select 1 - 5V DC for output)
- 2: Output (Select 1 - 5V DC for input)

[3] POWER INPUT

AC Power

K: 85 - 132 V AC
(Operational voltage range 85 - 132 V, 47 - 66 Hz)

DC Power

R: 24 V DC
(Operational voltage range 24 V \pm 10 %, ripple 10 %p-p max.)

RELATED PRODUCTS

- Analog I/O Module (model: 61x)
- Match the power input specification for the 61x and M2BS2.

GENERAL SPECIFICATIONS

Capacity: 4, 8 or 16 positions

Connection

Power input: M3 screw terminals (torque 0.8 N·m)

Input and output: M3 screw terminals (torque 0.8 N·m)

Screw terminal: Nickel-plated steel

Isolation: I/O module to power to FG1

INSTALLATION

Power Consumption

•AC

Approx. 30 VA with 4 modules

Approx. 50 VA with 8 modules

Approx. 90 VA with 16 modules

Current consumption:

•DC

Approx. 1 A with 4 modules

Approx. 1.5 A with 8 modules

Approx. 2.5 A with 16 modules

Operating temperature: -5 to +55°C (23 to 131°F)

Operating humidity: 30 to 90 %RH (non-condensing)

Atmosphere: No corrosive gas or heavy dust

Mounting: Surface

Weight: Without I/O module

M2BS2-04 1.0 kg (2.2 lb)

M2BS2-08 1.3 kg (2.9 lb)

M2BS2-16 1.8 kg (4.0 lb)

PERFORMANCE

Insulation resistance: \geq 100 M Ω with 500 V DC

Dielectric strength: 1000 V AC @1 minute (I/O module to power to FG1)



DIMENSIONS unit: mm (inch)

■ M2BS2-041 (INPUT BASE)

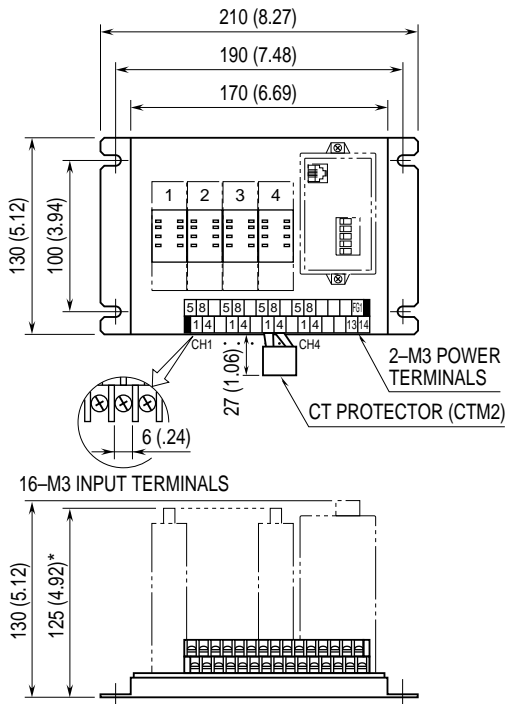

*165 (6.50) required for pneumatic tubing for M2PV.

■ M2BS2-042 (OUTPUT BASE)

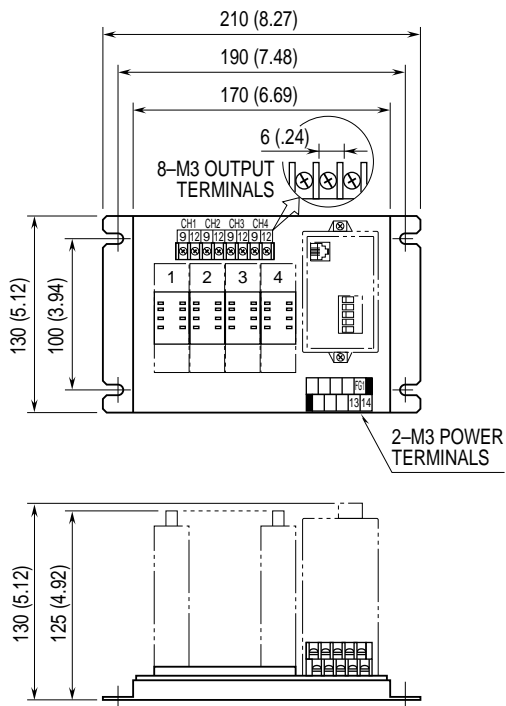

■ M2BS2-081 (INPUT BASE)

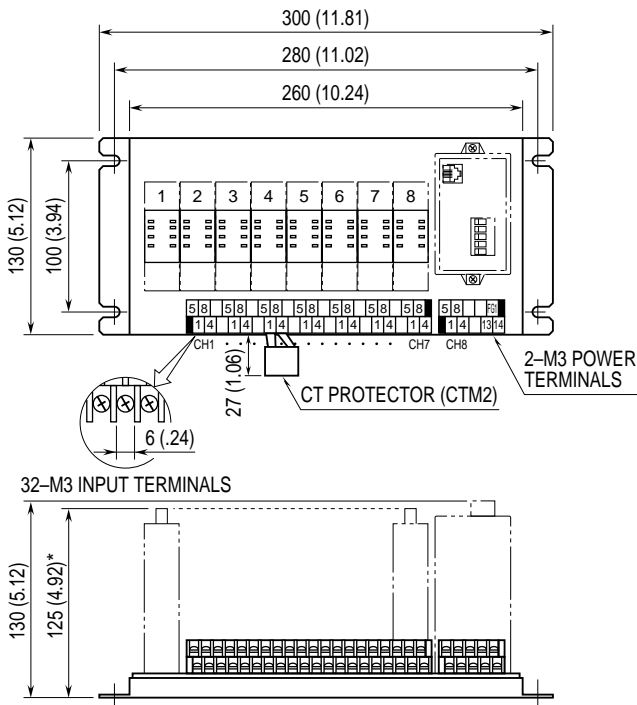

*165 (6.50) required for pneumatic tubing for M2PV.

■ M2BS2-082 (OUTPUT BASE)

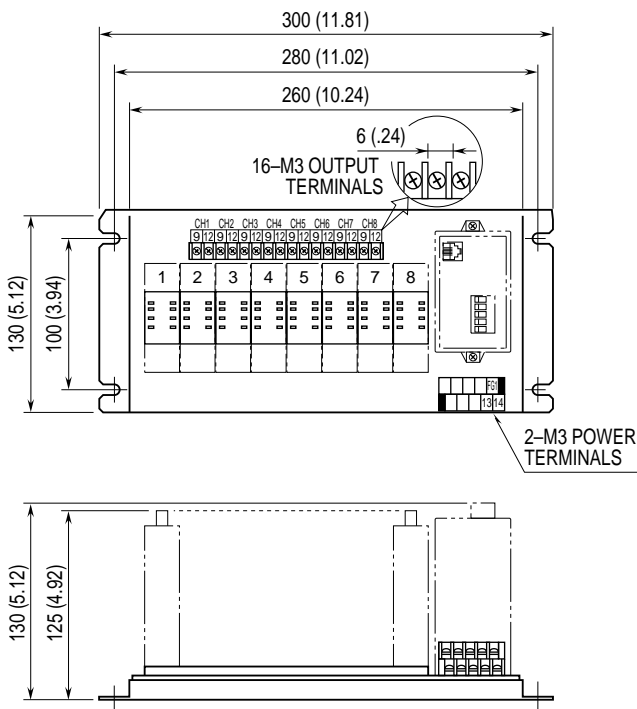

■ M2BS2-161 (INPUT BASE)

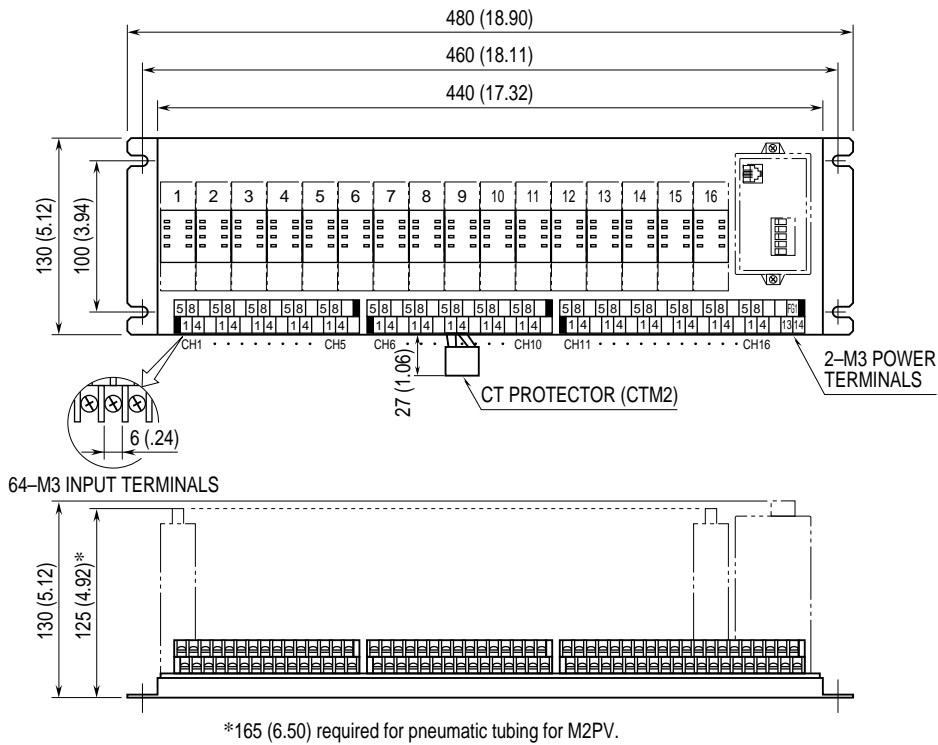

■ M2BS2-162 (OUTPUT BASE)

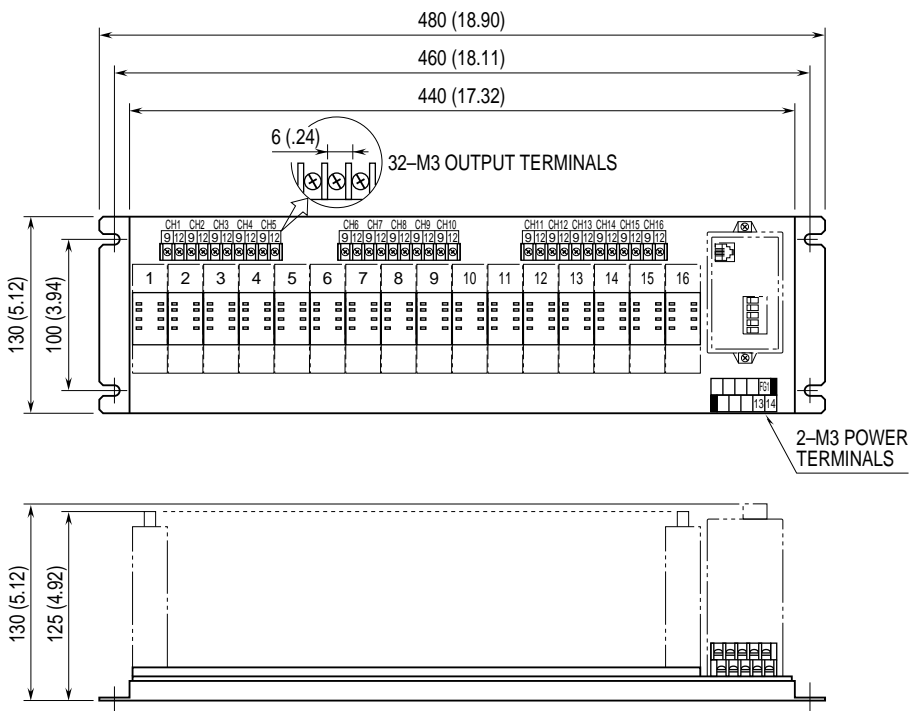

MOUNTING REQUIREMENTS unit: mm (inch)

■ M2BS2-04

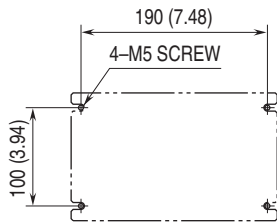

■ M2BS2-08

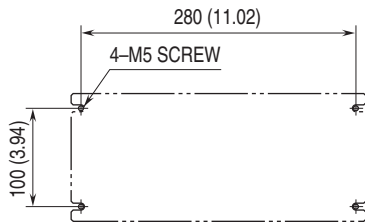

■ M2BS2-16

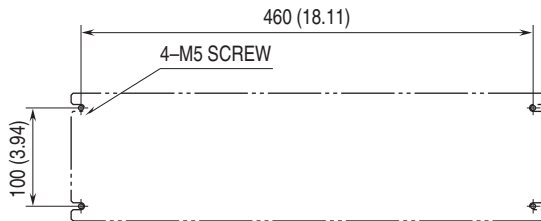

CONNECTION DIAGRAM

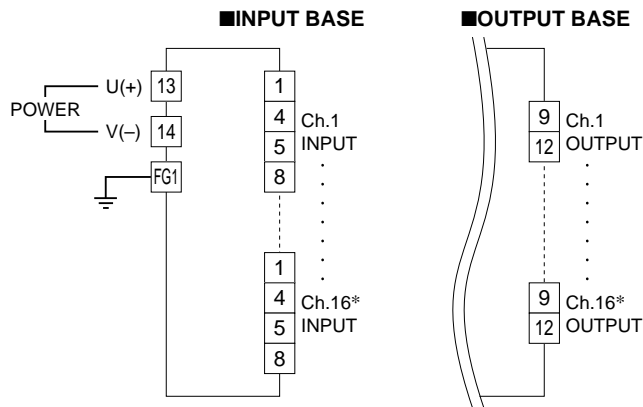

*Up to Ch.4 for M2BS2-04, Ch.8 for M2BS2-08.



Specifications are subject to change without notice.