

Plug-in Signal Conditioners M-UNIT

PULSE ISOLATOR

(built-in excitation)

Functions & Features

- Galvanically isolating pulse rate signals
- Input frequency = output frequency
- Various outputs (relay, open collector and voltage pulses)
- Excitation
- Isolation up to 2000 V AC
- High-density mounting

Typical Applications

- Isolating field pulse signals in order to reduce noises
- Changing e.g. dry contact signal to e.g. 5 V signals

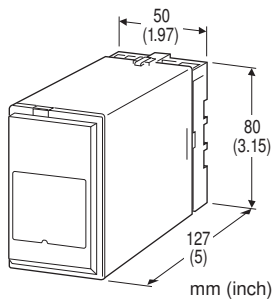

MODEL: YPD-[1][2][3][4][5]-[6][7]

ORDERING INFORMATION

- Code number: YPD-[1][2][3][4][5]-[6][7]
- Specify a code from below for each [1] through [7]. (e.g. YPD-D4A23N-B/Q)
- Frequency range (e.g. 0 - 5 Hz)
- Output pulse width (e.g. 75 msec.)
- Use Ordering Information Sheet (No. ESU-1369).
- Specify the specification for option code /Q (e.g. /C01/S01)

[1] INPUT

- A: Dry contact
- B: Voltage pulse (Specify sensitivity)
- C: 5 V pulse (sensitivity 2 V)
- D: 12 V/24 V pulse (sensitivity 5 V)
- H: Two-wire current pulse

[2] EXCITATION

- 1: 5 V DC / 80 mA
- 4: 12 V DC / 40 mA

[3] OUTPUT

- A1: Open collector (max. frequency 100 kHz)
- A2: Open collector (max. frequency 10 Hz)
- M1: 5 V pulse (max. frequency 100 kHz)
- M2: 5 V pulse (max. frequency 10 Hz)
- N1: 12 V pulse (max. frequency 100 kHz)
- N2: 12 V pulse (max. frequency 10 Hz)
- H: Relay contact (max. frequency 0.5 Hz)

[4] OUTPUT PULSE WIDTH

- 1: Equal to the input
- 2: One-shot output (≤ 30 ms; std. pulse width 5 ms) (Specify when optional pulse width is required.) (10 ms for relay contact pulse)
- 3: One-shot output (≥ 30 ms; std. pulse width 50 ms) (Specify when optional pulse width is required.)

[5] OUTPUT LOGIC

- N: The same as the input
- R: Inverted

[6] POWER INPUT

- AC Power**
- B: 100 V AC
- C: 110 V AC
- D: 115 V AC
- F: 120 V AC
- G: 200 V AC
- H: 220 V AC
- J: 240 V AC
- DC Power**
- S: 12 V DC
- R: 24 V DC
- V: 48 V DC

[7] OPTIONS

- blank: none
- /Q: With options (specify the specification)

SPECIFICATIONS OF OPTION: Q (multiple selections)

COATING (For the detail, refer to M-System's web site.)

- /C01: Silicone coating
- /C02: Polyurethane coating
- /C03: Rubber coating

TERMINAL SCREW MATERIAL

- /S01: Stainless steel



GENERAL SPECIFICATIONS

Construction: Plug-in
Connection: M3.5 screw terminals
Screw terminal: Chromated steel (standard) or stainless steel
Housing material: Flame-resistant resin (black)
Isolation: Input to output to power
Excitation adjustment: 5 - 12 V DC
Input pulse sensing: DC coupled
Input filter: Provided with output code A2, M2, N2, H (time constant approx. 1 msec.)

INPUT SPECIFICATIONS

Excitation: Shortcircuit protection; approx. 150 mA at shortcircuit

■ **Dry Contact**

Max. frequency: 100 kHz
Pulse width time requirement: 5 μ sec. min. (10 ms for output code A2, M2, N2, H)
Sensing: 10 V DC @ 2.5 mA
ON/OFF level:

≥ 5.5 k Ω / 5.5 V for OFF
 ≤ 1.8 k Ω / 4.5 V for ON

■ **Voltage Pulse:** Specify DC offset and amplitude.

Max. frequency: 100 kHz
Pulse width time requirement: 5 μ sec. min. (10 ms for output code A2, M2, N2, H)
Waveform: Square or sine
Input impedance: 10 k Ω min.
Input amplitude: 2 - 50 V_{p-p}
Offset: 2 - 10 V

Max. voltage between input terminals: 50 V

• **5V, 12V, 24V Pulse**

Waveform: Square or sine
Input impedance: 10 k Ω min.

Detecting level

INPUT	5 V PULSE	12 V / 24 V PULSE
V_H	≥ 2.25 V	≥ 5.25 V
V_L	≤ 1.75 V	≤ 4.75 V

■ **Two-wire Current Pulse**

Max. frequency: 100 kHz
Pulse width time requirement: 5 μ sec. min. (10 ms for output code A2, M2, N2, H)
Input resistance: Receiving resistor 220 Ω
Maximum current: ± 50 mA
Hi/Lo level: ≤ 5 mA for Lo, ≥ 15 mA for Hi

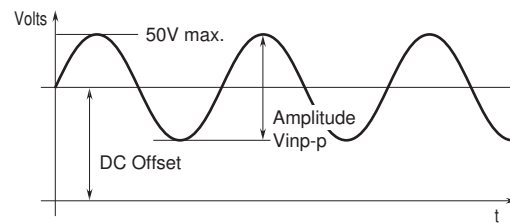
Voltage pulse waveform**OUTPUT SPECIFICATIONS**■ **Open Collector:** 50 V DC @ 50 mA (resistive load)**Maximum frequency:**

Output code A1: 100 kHz with load resistance ≤ 1 k Ω
 Output code A2: 10 Hz with load resistance ≤ 1 k Ω

Saturation voltage: 0.5 V DC■ **Voltage Pulse:** Rating (5 or 12 V) ± 10 %**Maximum frequency:** 100 kHz**Load resistance:** 1.5 k Ω min. for 5 V, 3 k Ω min. for 12 V**L level:** ≤ 0.5 V■ **Relay Contact:** 120 V AC or 30 V DC @ 200 mA

(resistive load)

Maximum switching voltage: 250 V AC or 30 V DC**Maximum switching power:** 50 VA or 6 W**Minimum load:** 5 V DC @ 10 mA**Maximum frequency:** 0.5 Hz**Relay life:**

2×10^7 cycles (mechanical)

7×10^6 cycles (electrical)

OUTPUT PULSE WIDTH

- **Equal to the Input:** No pulse width conversion (difference between input and output within ± 10 μ sec.)
- **One-shot Output:** Constant pulse width
Output Frequency (Hz) = 500 / (Output Pulse Width (msec.))

Adjustable pulse width**Pulse width max. 30 msec. (code 2):**

1 - 30 msec. adjustable (standard 5 msec. ± 20 %) for 'Output' code other than 'H'

10 - 30 msec. adjustable (standard 10 msec. ± 20 %) for 'Output' code 'H'

Pulse width min. 30 msec. (code 3): 30 msec. - 1 sec. adjustable (standard 50 msec. ± 20 %)

INSTALLATION**Power input**

• **AC:** Operational voltage range: rating ± 10 %, 50/60 ± 2 Hz, approx. 2.5 VA

• **DC:** Operational voltage range: rating ± 10 %, ripple 10 %p-p max., approx. 2 W (80 mA at 24 V)

Operating temperature: -5 to +60°C (23 to 140°F)

Operating humidity: 30 to 90 %RH (non-condensing)



Mounting: Surface or DIN rail

Weight: 400 g (0.88 lb)

PERFORMANCE



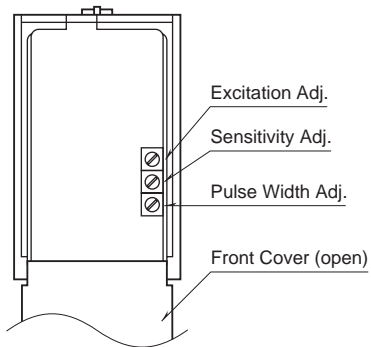

Insulation resistance: $\geq 100 \text{ M}\Omega$ with 500 V DC

Dielectric strength: 2000 V AC @1 minute (input to output to power to ground)

EXTERNAL VIEW



OUTPUT LOGIC

OUTPUT WAVEFORM		INPUT WAVEFORM	VOLTAGE PULSE or 2-WIRE CURRENT PULSE	DRY CONTACT
			H L	OFF ON
NON INVERTED	No pulse width conversion	Voltage pulse	H L	H L
		Open collector or relay contact	OFF ON	OFF ON
	One-shot, detecting input pulse rise 	Voltage pulse	H L	H L
		Open collector or relay contact	OFF ON	OFF ON
	One-shot, detecting input pulse sink 	Voltage pulse	H L	H L
		Open collector or relay contact	OFF ON	OFF ON
INVERTED	No pulse width conversion	Voltage pulse	H L	H L
		Open collector or relay contact	OFF ON	OFF ON
	One-shot, detecting input pulse rise 	Voltage pulse	H L	H L
		Open collector or relay contact	OFF ON	OFF ON
	One-shot, detecting input pulse sink 	Voltage pulse	H L	H L
		Open collector or relay contact	OFF ON	OFF ON

The pulse width in one-shot means the bold lined section of a pulse waveform.

 Shades indicate default setting.

Input pulse rise/sink detected with voltage level



DIMENSIONS unit: mm (inch)

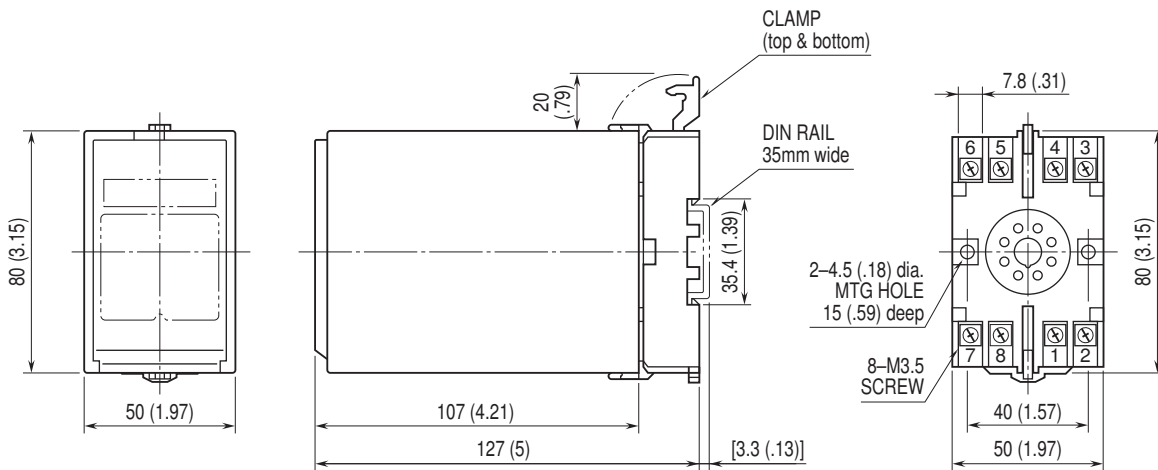

• When mounting, no extra space is needed between units.

SCHEMATIC CIRCUITRY & CONNECTION DIAGRAM

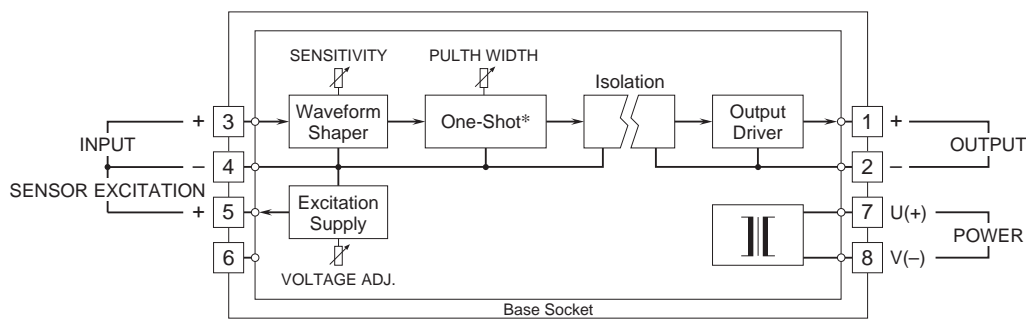

*Provided only when the one-shot output is specified.

Input Connection Examples

■ Dry Contact

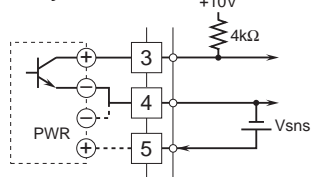

■ 2-Wire Current Pulse •Built-in Excitation

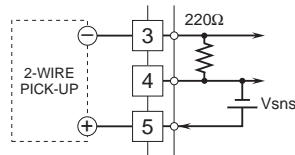

■ Voltage Pulse

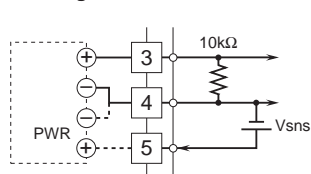

• External DC Supply

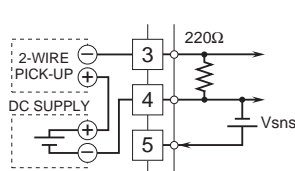

Output Connection Examples

■ Open Collector

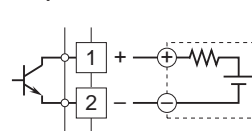

■ Voltage Pulse

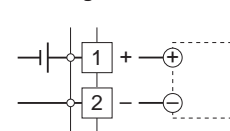

■ Relay Contact •AC Powered

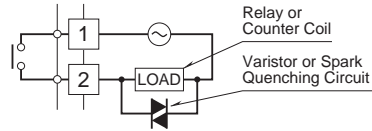

•DC Powered

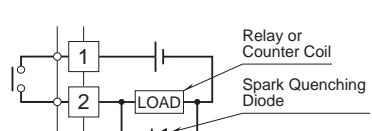



Specifications are subject to change without notice.

