

Remote I/O R6 Series

CC-Link INTERFACE MODULE

(CC-Link Ver.2.00; for 64-point analog signals)

Functions & Features

- Free combination of analog and discrete I/O
- Direct sensor inputs
- Space-saving
- Low power consumption

Typical Applications

- Remote I/O for DCS and PLC

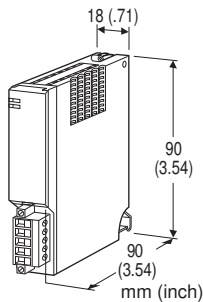

MODEL: R6-NC3[1]

ORDERING INFORMATION

- Code number: R6-NC3[1]

Specify a code from below for [1]

(e.g. R6-NC3/W)

[1] OPTIONS

Dual network

blank: Unavailable

/W: Available

GENERAL SPECIFICATIONS

Connection

Network: Euro type connector terminal

Internal bus: Via the Installation Base (model: R6x-BS)

Power supply: Via the Installation Base (model: R6x-BS)

Max. number of I/O modules: 32 (analog 64 points)

Isolation: CC-Link to internal bus or internal power

RUN indicator: Bi-color (green/red) LED; green in normal communications; red when receiving (Function selected with DIP SW3)

ERR indicator: Bi-color (green/red) LED; the green ON/ blinks in communication errors; red when transmitting (Function selected with DIP SW3)

Data allocation: 1 or 2 set with the side DIP switch

CC-Link COMMUNICATION

Protocol: CC-Link. Conforms to Version 2.00 (incompatible with Ver.1)

Device type: Remote device station

Required nodes: 4 (112 I/O points, 16 words) × m (m = Cyclic expansion setting)

Network cable: Approved for CC-Link

Cyclic expansion: 2, 4 (Function selected with DIP SW3)

Station address setting: Rotary switch; 1 to 64

Baud rate setting: Rotary switch

156kbps, 625kbps, 2.5Mbps, 5Mbps, 10Mbps

INSTALLATION

Operating temperature: -10 to +55°C (14 to 131°F)

Operating humidity: 30 to 90 %RH (non-condensing)

Atmosphere: No corrosive gas or heavy dust

Mounting: Installation Base (model: R6x-BS)

Weight: 100 g (3.53 oz)

PERFORMANCE

Insulation resistance: ≥ 100 MΩ with 500 V DC

Dielectric strength: 1500 V AC @ 1 minute (CC-Link to internal bus or internal power)



NETWORK REDUNDANT SYSTEM

The dual network system is only available using two (2) interface modules (with option /W). In case that a single interface module is mounted, RUN and ERR indicator LED turn off. Before turn on the power, be sure to mount two interface modules. The modules must be mounted on a 36.5 mm width base (model: R6x-BS8B). Please, be sure to set always one of the two (2) interface modules' SW8 as main, and the other one as sub. If the both modules are set as main or both as sub, none of them is operable. When the main network module is in main-operation mode, the sub network module is in sub-operation mode. The main-operating module is able to transmit input data and to set output data. The sub-operating module is able to input data. However, since the main-operating module has the priority, the sub-operating module is not able to set output data. In case of communication error, failure or detachment in the main network module, the sub network module takes over the main-operation. When the failed main network module is replaced or its transmission is recovered, its operation mode is selectable with DIP SW.

■ OPERATION EXAMPLE

• Restart with Main-operation Mode

When the main network module recovers during sub network module is in main-operation mode, the main takes over main-operation again. The main network module waits for the time preset with the configurator software (model: R6CON) to take over the main-operation mode. Please refer to the instruction manual of R6CON for details.

States of Network Modules

	STATE TRANSITION		OPERATION MODE		LED INDICATOR	
	MAIN MODULE	SUB MODULE	MAIN MODULE	SUB MODULE	MAIN MODULE	SUB MODULE
1	Normal transmission	Normal transmission	Main-operation	Sub-operation	Green ON	Green blinking
2	Normal transmission	Transmission error, Failure	Main-operation	Sub-operation	Green ON	OFF
3	Normal transmission	Restart normally	Main-operation	Sub-operation	Green ON	Green blinking
4	Transmission error, Failure	Normal transmission	Sub-operation	Main-operation	OFF	Green ON
5	Restart normally	Normal transmission	Main-operation	Sub-operation	Green ON	Green blinking

• Restart with Sub-operation Mode

When the main network module recovers during sub network module is in main-operation mode, the main network modules restarts with sub-operation mode.

States of Network Modules

	STATE TRANSITION		OPERATION MODE		LED INDICATOR	
	MAIN MODULE	SUB MODULE	MAIN MODULE	SUB MODULE	MAIN MODULE	SUB MODULE
1	Normal transmission	Normal transmission	Main-operation	Sub-operation	Green ON	Green blinking
2	Normal transmission	Transmission error, Failure	Main-operation	Sub-operation	Green ON	OFF
3	Normal transmission	Restart normally	Main-operation	Sub-operation	Green ON	Green blinking
4	Error, Failure	Normal transmission	Sub-operation	Main-operation	OFF	Green ON
5	Restart normally	Normal transmission	Sub-operation	Main-operation	Green blinking	Green ON
6	Normal transmission (Power reset)	Normal transmission (Power reset)	Main-operation	Sub-operation	Green ON	Green blinking



EXTERNAL VIEW

■ SIDE VIEW

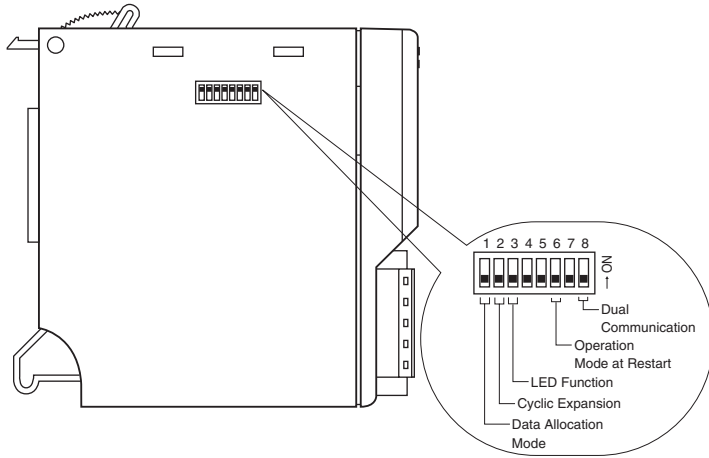

■ FRONT VIEW

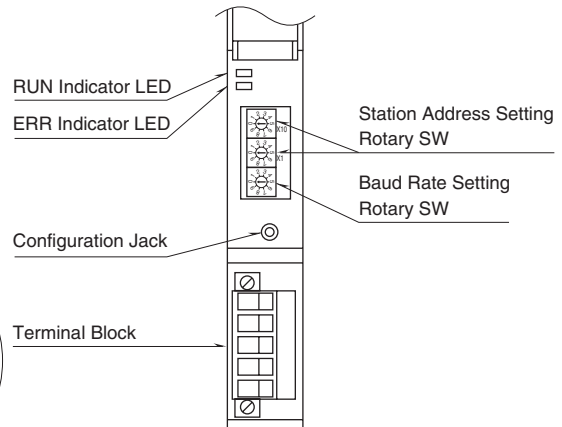

COMMUNICATION CABLE CONNECTIONS

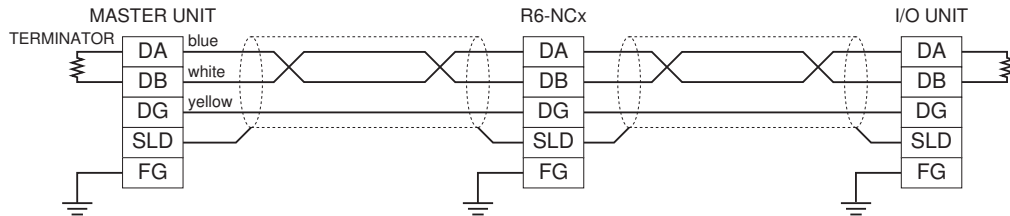

TRANSMISSION DATA DESCRIPTIONS

The DIP SW located at the side of the module switches the unit's data allocation mode.

In the Data Allocation Mode 1, one (1) word is assigned per module. The second channel of analog I/O modules cannot be used.

In the Data Allocation Mode 2, two (2) words are assigned per module regardless of whether the second word area is required or not, even for discrete I/O modules that require one (1) word.

A maximum of 32 I/O modules can be mounted per node.

Each Status data is available when the Ready is "1" (the internal bus in normal condition). While the Ready is "0," all of the Status data is "0" (the internal bus in abnormal condition).

DATA ALLOCATION MODE 1

• Output Data

The figure below shows the allocation of data sent from the network module to the master.

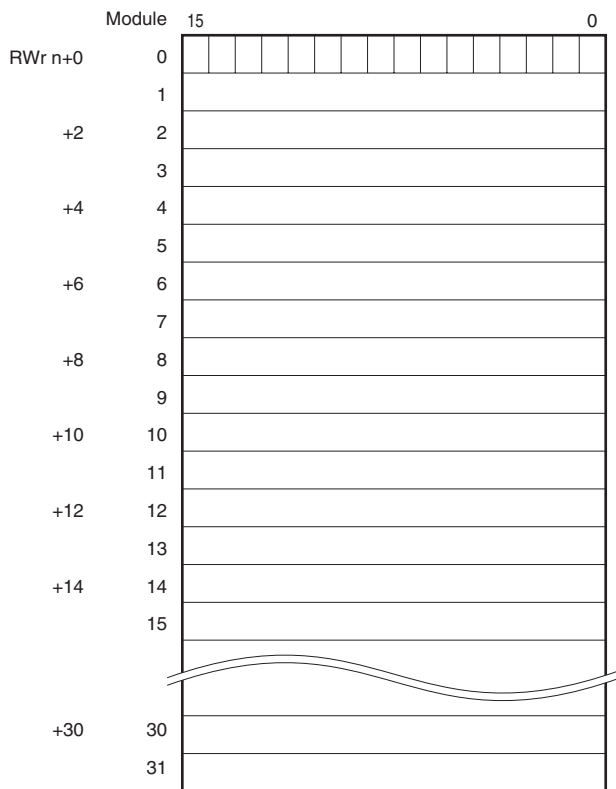

• Input Data

The figure below shows the allocation of data sent from the master to the network module.

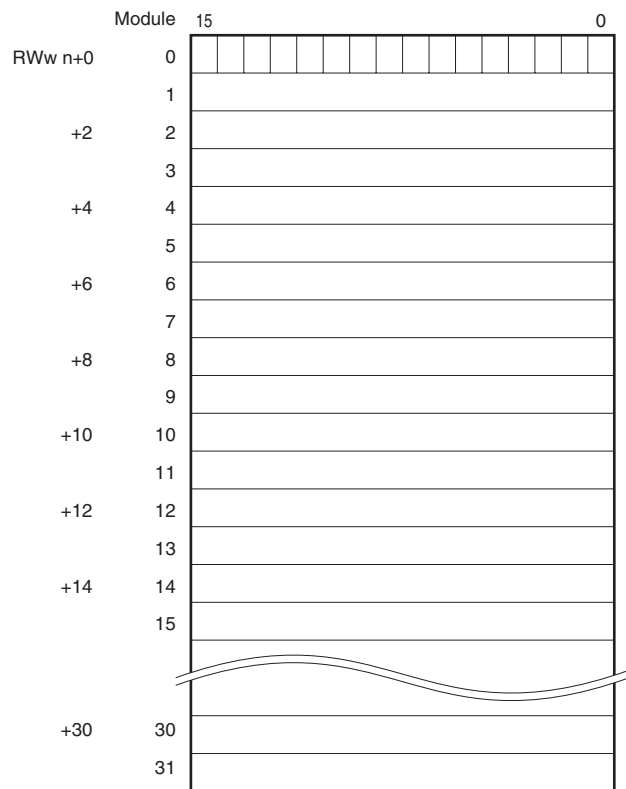

16 × m (m = cyclic expansion setting) data areas are available for this module.

In Data Allocation Mode 1, set Cyclic Expansion two (2). When Cyclic Expansion setting is 4, data of module address 32 or larger is invalid.

Field input data is set in the module's output data area. The input data area is also secured though not used for an input module.

• Module Status

RX (n+0) 0 through RX (n+1) 15 indicate that modules are mounted in each slot.

0: mounted; 1: not mounted.

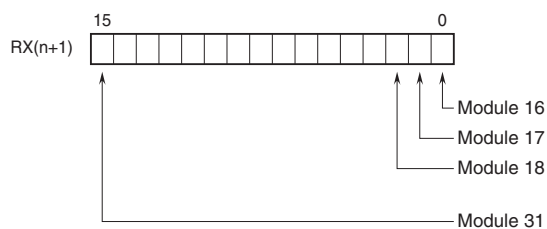
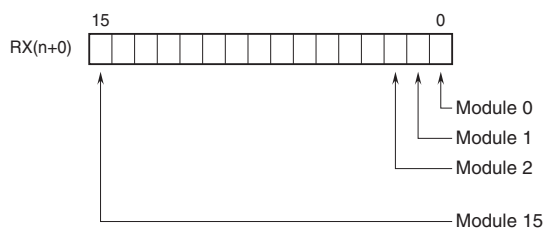

• Hardware Error Status

RX (n+2) 0 through RX (n+5) 15, indicate following I/O Error.

0: normal; 1: error

Burn out of R6x-TSx, R6x-RSx

Current Output Error of R6x-YSx (Load resistor no connection etc.)

Input Circuit failure

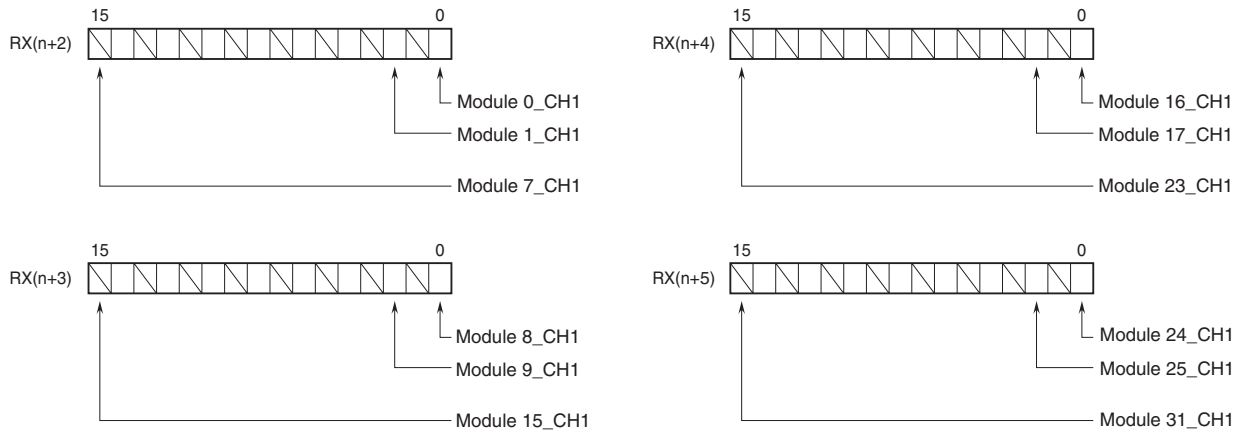

Note: In Data Allocation mode "1," CH2' is invalid, and its all bits turn to "0."

• Data Error Status

RX (n+6) 0 through RX (n+9) 15 indicate following I/O module data error.

0: normal; 1: error

The input values of the analog input module except R6x-TSx and R6x-RSx are -15 or less, or +115 or more.

Input of R6x-TSx, R6x-RSx are burn out.

Current Output Error of R6x-YSx (Load resistor no connection etc.)

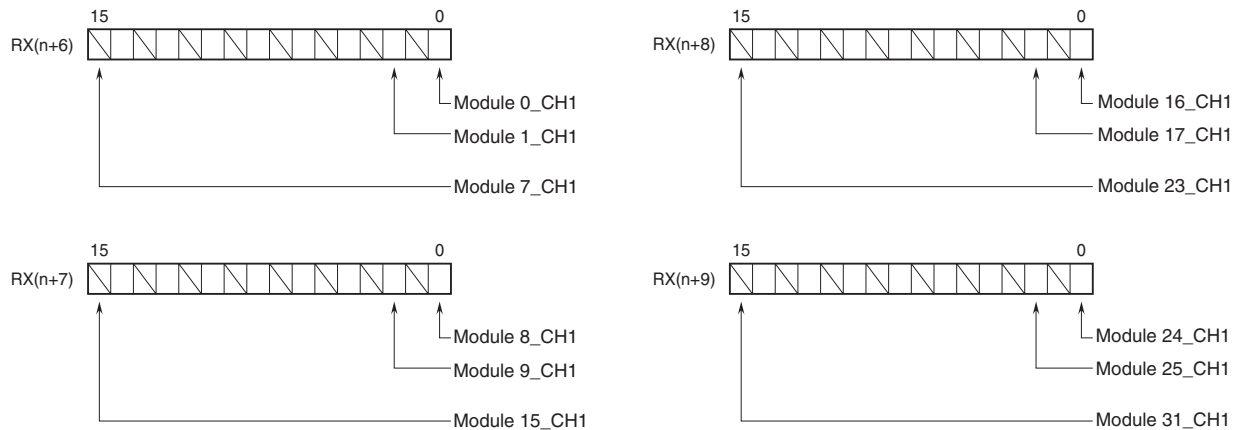

Note: In Data Allocation mode "1," CH2 is invalid, and its all bits turn to "0."

• Internal Bus Status

RX (n+10) 0 through RX (n+10) 15 indicate the module's status.

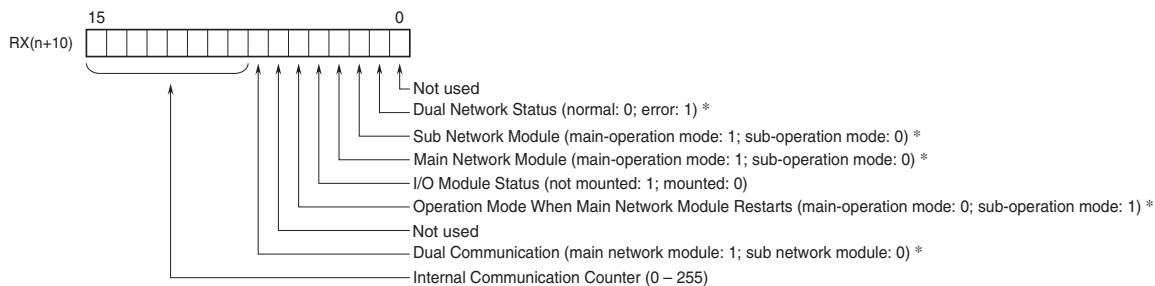

*Effective only for option code /W. For other models, all bits are "0."



• Ready

RX (n+13) 11 is assigned to Ready signal, which turns to “1” when the internal bus is in normal conditions.

■ DATA ALLOCATION MODE 2

• Output Data

The figure below shows the allocation of data sent from the network module to the master.

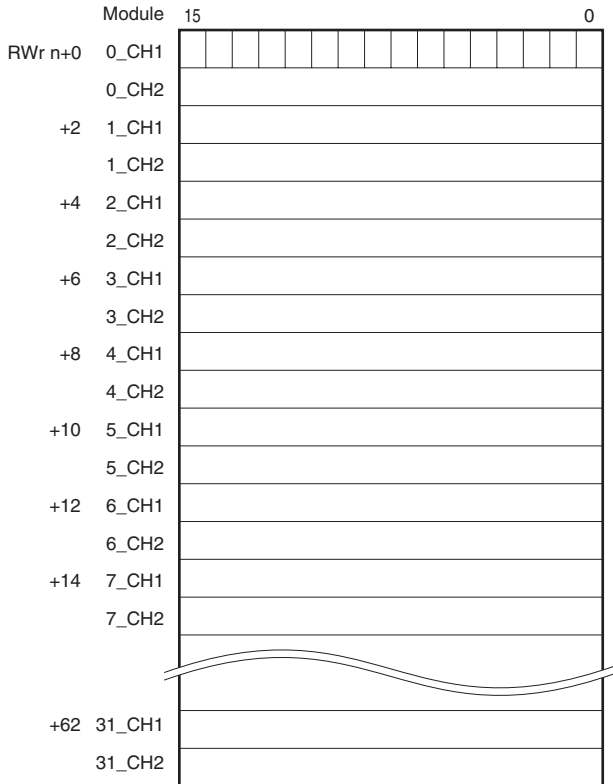

• Input Data

The figure below shows the allocation of data sent from the master to the network module.

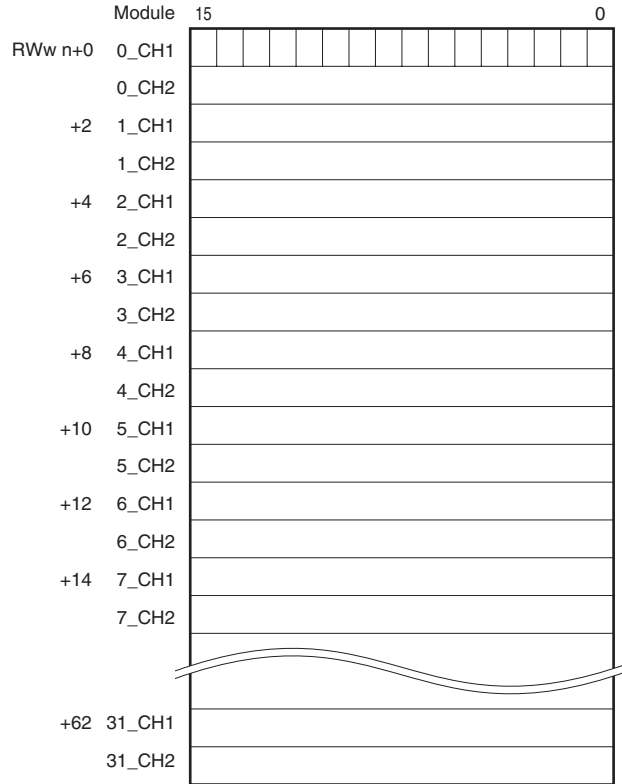

16 × m (m = cyclic expansion setting) data areas are available for this module.

Field input data is set at the module's output data area. The input data area is also secured though not used for an input module.

• Module Status

RX (n+0) 0 through RX (n+1) 15 indicate that modules are mounted in each slot.

0: mounted; 1: not mounted.

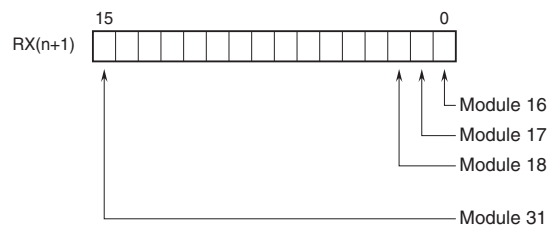
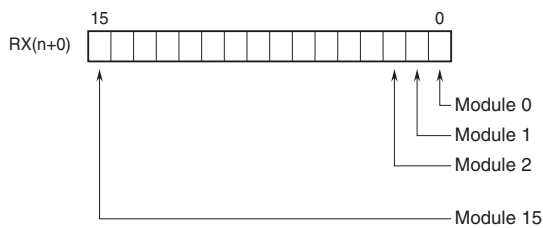

• Hardware Error Status

RX (n+2) 0 through RX (n+5) 15, indicate following I/O Error.

0: normal; 1: error

Burn out of R6x-TSx, R6x-RSx

Current Output Error of R6x-YSx (Load resistor no connection etc.)

Input Circuit failure

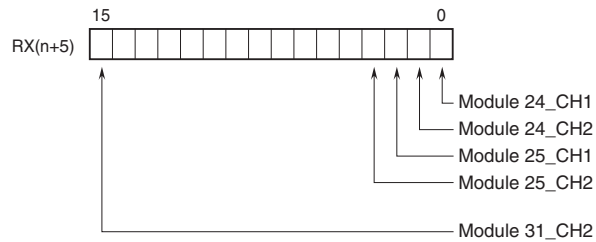
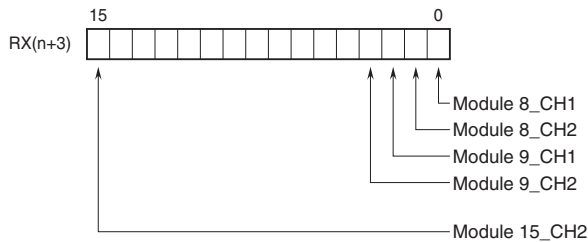
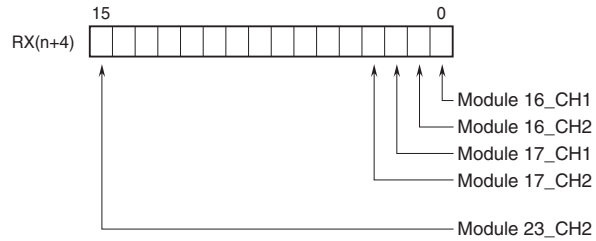
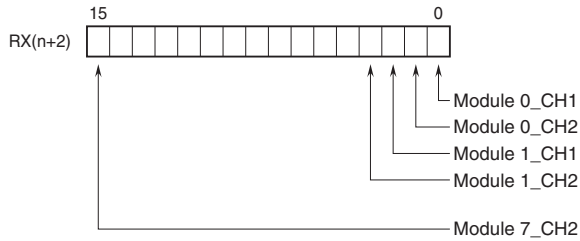

• Data Error Status

RX (n+6) 0 through RX (n+9) 15 indicate following I/O module data error.

0: normal; 1: error

The input values of the analog input module except R6x-TSx and R6x-RSx are -15 or less, or +115 or more.

Input of R6x-TSx, R6x-RSx are Burn out.

Current Output Error of R6x-YSx (Load resistor no connection etc.)

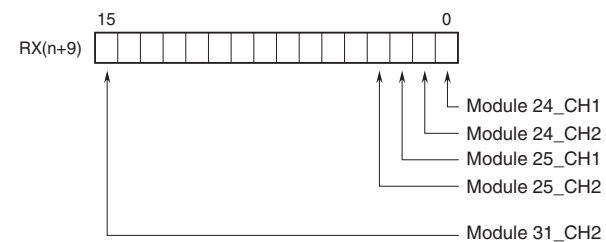
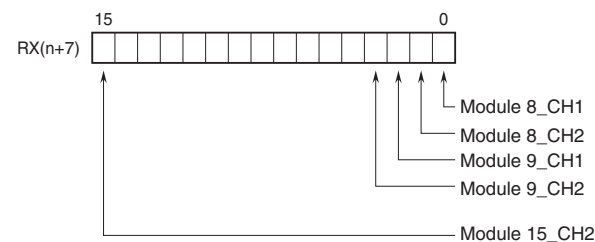
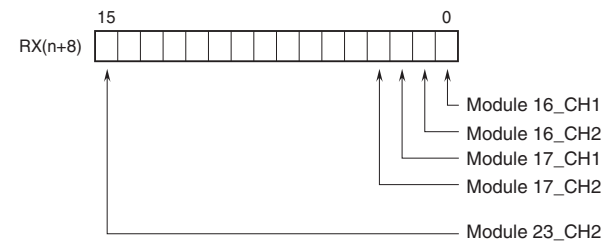
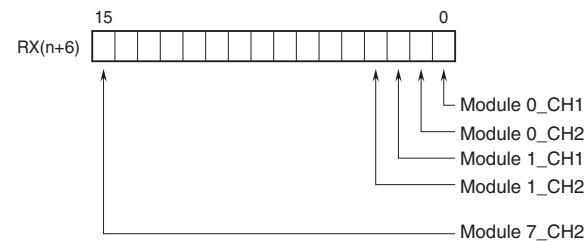

• Internal Bus Status

RX (n+10) 0 through RX (n+10) 15 indicate the module's status.

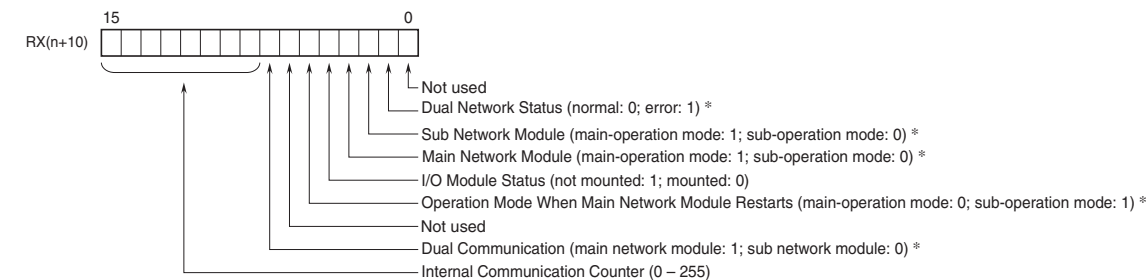

*Effective only for option code /W. For other models, all bits are "0."



• **Ready**

RX (n+27) 11 is assigned to Ready signal, which turns to "1" when the internal bus is in normal conditions.

I/O DATA DESCRIPTIONS

■ ANALOG DATA

0 to 100% of the selected I/O range is converted into 0 to 10000 (binary).

With °C or Kelvin temperature unit, raw data is multiplied by 10. For example, 25.5°C is converted into 255.

With °F temperature unit, the integer section of raw data is directly converted into the data. For example, 135.4°F is converted into 135.

Negative values are represented in 2's complements.



■ DISCRETE DATA

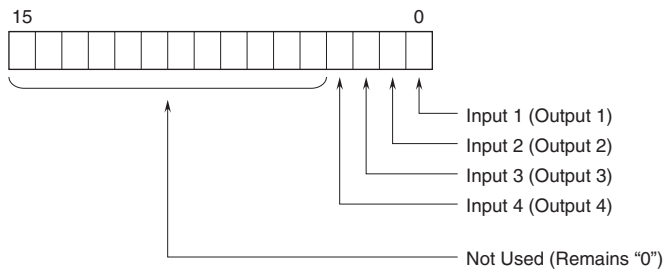

0 : OFF
1 : ON

DIMENSIONS unit: mm (inch)

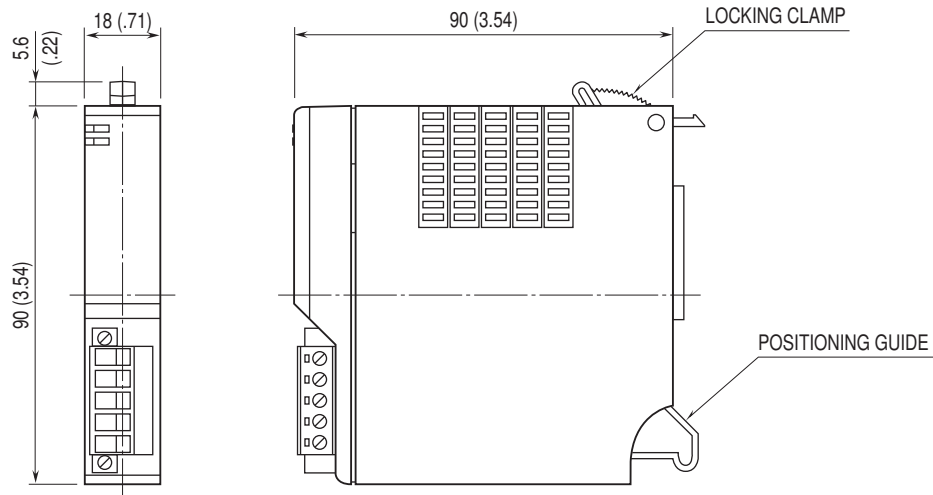

SCHEMATIC CIRCUITRY & CONNECTION DIAGRAM

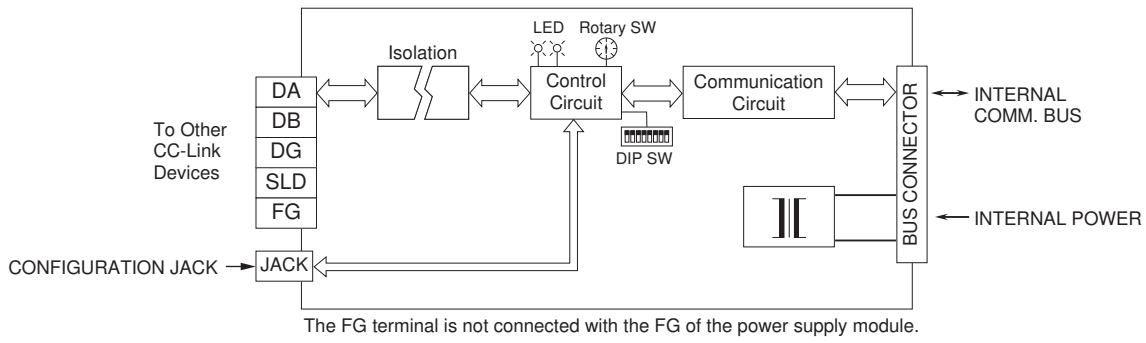

Specifications are subject to change without notice.

