

Remote I/O R3 Series

ONE-SHOT PULSE OUTPUT MODULE

(relay contact output, 16 points)

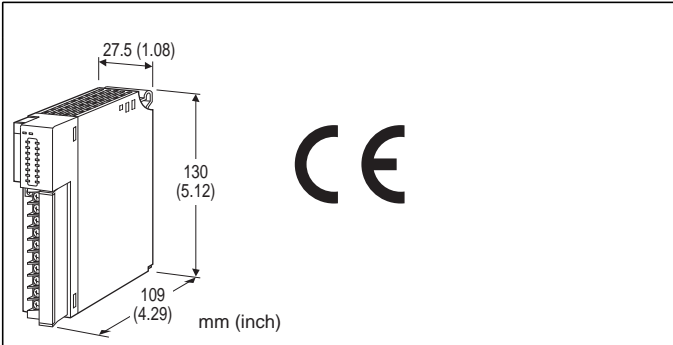

MODEL: R3-PD16[1][2]

ORDERING INFORMATION

- Code number: R3-PD16[1][2]
- Specify a code from below for each [1] and [2].
(e.g. R3-PD16W/CE/Q)
- Specify the specification for option code /Q
(e.g. /C01)

NO. OF CHANNELS

16: 16

[1] COMMUNICATION MODE

S: Single
W: Dual

[2] OPTIONS (multiple selections)

Standards & Approvals

blank: Without CE
/CE: CE marking

Other Options

blank: none
/Q: Option other than the above (specify the specification)

SPECIFICATIONS OF OPTION: Q

COATING (For the detail, refer to M-System's web site.)

/C01: Silicone coating
/C02: Polyurethane coating
/C03: Rubber coating

RELATED PRODUCTS

- Interface module (model: R3-Nx)
- Output completion status is compatible with interface

modules model: R3-NC1, -NC3, -NE1, -NM1 and -NDx of firmware version V2.00 or higher. Other interface modules are not compatible. So, set I/O Mode as output (SW2-7: ON) to use it.

Note: R3-NL1 and R3-NL2 are not available with this model.

GENERAL SPECIFICATIONS

Connection

Internal bus: Via the Installation Base (model: R3-BSx)

Output: M3 separable screw terminal (torque 0.5 N·m)

Internal power: Via the Installation Base (model: R3-BSx)

Screw terminal: Nickel-plated steel

Isolation: Output to internal bus or internal power

Output mode setting: One-Shot Output Mode, ON/OFF Control Output Mode, Continuance Output Mode selectable with DIP switch

Output data length: 16bit, 8bit selectable with DIP switch
(For ON/OFF Control Output Mode only)

I/O mode setting: Output Complete Status ON/OFF is selectable with DIP switch

Output ON time: 0.1 to 25.6 sec. selectable with DIP switch

ON/OFF control output channel: Swappable its pair with DIP switch.

Output hold function: Setting for communication error with side DIP SW (available in continuance output mode)

RUN indicator: Bi-color (red/green) LED;
Red when the bus A operates normally;
Green when the bus B operates normally;
Amber when both buses operate normally.

ERR indicator: Bi-color (red/ green) LED;
Green in normal operating conditions
Red with the abnormal configuration

Output status indicator: Red LED; turns on with the output ON.

OUTPUT SPECIFICATIONS

Output: Relay contact, 16 points

Common: All 16 points (4 terminals)

Common current: Max. 4 A (total of 4 terminals)

Rated load: 250 V AC @ 0.5A (cos $\theta = 1$)
(Max. 50 V AC to conform with EC Directive.)
30 V DC @ 0.5 A (resistive load)
electrical life 10^5 cycles (6 cycles/min.)

Maximum switching voltage: 250 V AC or 30 V DC

Maximum switching power: 250 VA or 30 W

Minimum load: 1 V DC @ 1 mA

Mechanical life: 2×10^7 cycles (300 cycles/min.)

When driving an inductive load, external contact protection and noise quenching recommended.



INSTALLATION

Operating temperature: -10 to +55°C (14 to 131°F)
Operating humidity: 30 to 90 %RH (non-condensing)
Atmosphere: No corrosive gas or heavy dust
Mounting: Installation Base (model: R3-BSx)
Weight: 200 g (0.44 lb)

PERFORMANCE

Output ON time accuracy:
±10 % for 1 sec. or less setting;
±0.1 sec. for 1 sec. or more setting
Data allocation: 1
Current consumption: 180 mA
Response time: ≤ 0.1 sec. (delay)
Insulation resistance: ≥ 100 MΩ with 500 V DC
Dielectric strength: 1500 V AC @ 1 minute
(output to internal bus or internal power)
2000 V AC @ 1 minute (power input to FG; isolated on the power supply module)

STANDARDS & APPROVALS

CE conformity:
EMC Directive (2004/108/EC)
EMI EN 61000-6-4: 2007/A1: 2011
EMS EN 61000-6-2: 2005

FUNCTIONS

■OUTPUT HOLD or OUTPUT OFF

In normal conditions, the module outputs the signal from the preferred bus A.

When an error is detected, the output is switched to the data from the bus B.

•Output Hold

If both are in error, the module holds the signal and stands by until one of the communications recovers.

•Output OFF

If both are in error, the module outputs OFF signals and stands by until one of the communications recovers.

At the startup, it outputs OFF until the communication is established and normal data is received.



EXTERNAL VIEW

FRONT VIEW

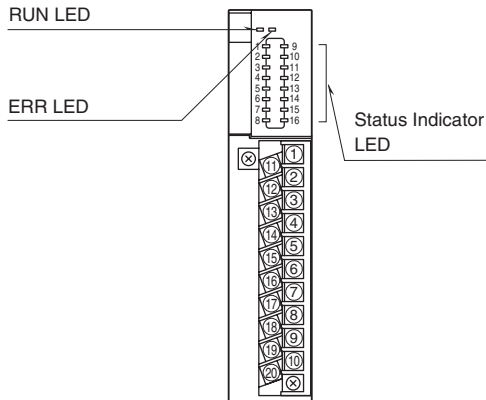

SIDE VIEW

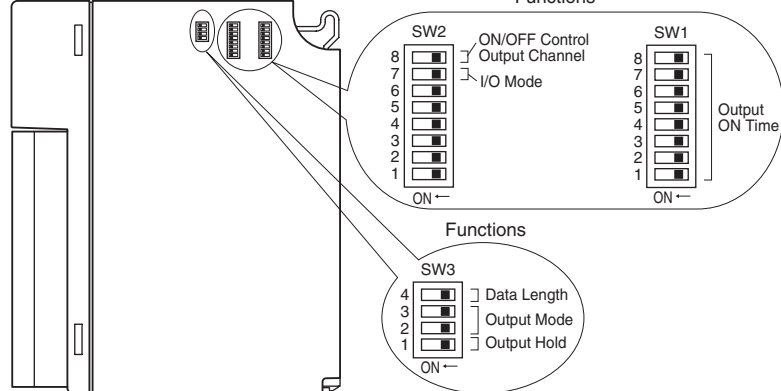

I/O DATA DESCRIPTIONS

ONE-SHOT OUTPUT MODE

16-bit output data (Do 1 through 16) and output (Ch1 through 16) are assigned 1:1.
When I/O Mode is in Output Operation (SW2-7: ON), Output Complete Status is not indicated.

Do	WRITE	ONE-SHOT OUTPUT/RESET	Di	OUTPUT COMPLETION STATUS
Do 1	1	Ch1 Output	Di 1	Ch1 Output Completion Status
	0	Ch1 Output Completion Reset		
Do 2	1	Ch2 Output	Di 2	Ch2 Output Completion Status
	0	Ch2 Output Completion Reset		
Do 3	1	Ch3 Output	Di 3	Ch3 Output Completion Status
	0	Ch3 Output Completion Reset		
Do 4	1	Ch4 Output	Di 4	Ch4 Output Completion Status
	0	Ch4 Output Completion Reset		
Do 5	1	Ch5 Output	Di 5	Ch5 Output Completion Status
	0	Ch5 Output Completion Reset		
Do 6	1	Ch6 Output	Di 6	Ch6 Output Completion Status
	0	Ch6 Output Completion Reset		
Do 7	1	Ch7 Output	Di 7	Ch7 Output Completion Status
	0	Ch7 Output Completion Reset		
Do 8	1	Ch8 Output	Di 8	Ch8 Output Completion Status
	0	Ch8 Output Completion Reset		
Do 9	1	Ch9 Output	Di 9	Ch9 Output Completion Status
	0	Ch9 Output Completion Reset		
Do 10	1	Ch10 Output	Di 10	Ch10 Output Completion Status
	0	Ch10 Output Completion Reset		
Do 11	1	Ch11 Output	Di 11	Ch11 Output Completion Status
	0	Ch11 Output Completion Reset		
Do 12	1	Ch12 Output	Di 12	Ch12 Output Completion Status
	0	Ch12 Output Completion Reset		
Do 13	1	Ch13 Output	Di 13	Ch13 Output Completion Status
	0	Ch13 Output Completion Reset		
Do 14	1	Ch14 Output	Di 14	Ch14 Output Completion Status
	0	Ch14 Output Completion Reset		
Do 15	1	Ch15 Output	Di 15	Ch15 Output Completion Status
	0	Ch15 Output Completion Reset		
Do 16	1	Ch16 Output	Di 16	Ch16 Output Completion Status
	0	Ch16 Output Completion Reset		



■ ON/OFF CONTROL OUTPUT MODE

• Data Length: 16 bits

Do 1 through 16 are assigned to Ch1 through 16.

When I/O Mode is in Output Operation (SW2-7: ON), Output Complete Status is not indicated.

Do	WRITE	ONE-SHOT OUTPUT/RESET	Di	OUTPUT COMPLETION STATUS
Do 1 Do 2	0 0	Not Operating		
	1 0	Ch1 Output	Di 1	Ch1 Output Completion Status
	0 1	Ch2 Output	Di 2	Ch2 Output Completion Status
	1 1	Output Data Reset		
Do 3 Do 4	0 0	Not Operating		
	1 0	Ch3 Output	Di 3	Ch3 Output Completion Status
	0 1	Ch4 Output	Di 4	Ch4 Output Completion Status
	1 1	Output Data Reset		
Do 5 Do 6	0 0	Not Operating		
	1 0	Ch5 Output	Di 5	Ch5 Output Completion Status
	0 1	Ch6 Output	Di 6	Ch6 Output Completion Status
	1 1	Output Data Reset		
Do 7 Do 8	0 0	Not Operating		
	1 0	Ch7 Output	Di 7	Ch7 Output Completion Status
	0 1	Ch8 Output	Di 8	Ch8 Output Completion Status
	1 1	Output Data Reset		
Do 9 Do 10	0 0	Not Operating		
	1 0	Ch9 Output	Di 9	Ch9 Output Completion Status
	0 1	Ch10 Output	Di 10	Ch10 Output Completion Status
	1 1	Output Data Reset		
Do 11 Do 12	0 0	Not Operating		
	1 0	Ch11 Output	Di 11	Ch11 Output Completion Status
	0 1	Ch12 Output	Di 12	Ch12 Output Completion Status
	1 1	Output Data Reset		
Do 13 Do 14	0 0	Not Operating		
	1 0	Ch13 Output	Di 13	Ch13 Output Completion Status
	0 1	Ch14 Output	Di 14	Ch14 Output Completion Status
	1 1	Output Data Reset		
Do 15 Do 16	0 0	Not Operating		
	1 0	Ch15 Output	Di 15	Ch15 Output Completion Status
	0 1	Ch16 Output	Di 16	Ch16 Output Completion Status
	1 1	Output Data Reset		

The above table shows the case of Not Swapped (SW2-8: OFF). ON/OFF control output is swapped with its pair when SW2-8 is ON. The following is an example of Do1 and Do2.

Do	WRITE	ONE-SHOT OUTPUT/RESET	Di	OUTPUT COMPLETION STATUS
Do 1 Do 2	0 0	Not Operating		
	1 0	Ch2 Output	Di 2	Ch2 Output Completion Status
	0 1	Ch1 Output	Di 1	Ch1 Output Completion Status
	1 1	Output Data Reset		



• **Data Length: 8 bits**

Do 1 through 8 are assigned to Ch1 through 16 as 1:2.

One (1) data sets two (2) outputs. When I/O Mode is in Output Operation (SW2-7: ON), Output Complete Status is not indicated.

Do	WRITE	ONE-SHOT OUTPUT/RESET	Di	OUTPUT COMPLETION STATUS
Do 1	0	Ch1 Output	Di 1	Ch1 Output Completion Status
	1	Ch2 Output	Di 2	Ch2 Output Completion Status
Do 2	0	Ch3 Output	Di 3	Ch3 Output Completion Status
	1	Ch4 Output	Di 4	Ch4 Output Completion Status
Do 3	0	Ch5 Output	Di 5	Ch5 Output Completion Status
	1	Ch6 Output	Di 6	Ch6 Output Completion Status
Do 4	0	Ch7 Output	Di 7	Ch7 Output Completion Status
	1	Ch8 Output	Di 8	Ch8 Output Completion Status
Do 5	0	Ch9 Output	Di 9	Ch9 Output Completion Status
	1	Ch10 Output	Di 10	Ch10 Output Completion Status
Do 6	0	Ch11 Output	Di 11	Ch11 Output Completion Status
	1	Ch12 Output	Di 12	Ch12 Output Completion Status
Do 7	0	Ch13 Output	Di 13	Ch13 Output Completion Status
	1	Ch14 Output	Di 14	Ch14 Output Completion Status
Do 8	0	Ch15 Output	Di 15	Ch15 Output Completion Status
	1	Ch16 Output	Di 16	Ch16 Output Completion Status

The above table shows the case of Not Swapped (SW2-8: OFF). ON/OFF control output is swapped with its pair when SW2-8 is ON. The following is an example of Do1.

Do	WRITE	ONE-SHOT OUTPUT/RESET	Di	OUTPUT COMPLETION STATUS
Do 1	0	Ch2 Output	Di 2	Ch2 Output Completion Status
	1	Ch1 Output	Di 1	Ch1 Output Completion Status

■ **CONTINUANCE OUTPUT MODE**

Do 1 through 16 are assigned to and Ch1 through 16. When data Do is "1" output is ON (energized) and when it is "0" output is OFF (de-energized). The operation is equivalent to 16 points discrete output module (model: R3-DC16). Output completion status Di is related to Do.

When I/O Mode is in Output Operation (SW2-7: ON), Output Complete Status is not indicated.

Do	CONTINUANCE OUTPUT	Di	OUTPUT COMPLETION STATUS
Do 1	Ch1 Output	Di 1	Ch1 Output Completion Status
Do 2	Ch2 Output	Di 2	Ch2 Output Completion Status
Do 3	Ch3 Output	Di 3	Ch3 Output Completion Status
Do 4	Ch4 Output	Di 4	Ch4 Output Completion Status
Do 5	Ch5 Output	Di 5	Ch5 Output Completion Status
Do 6	Ch6 Output	Di 6	Ch6 Output Completion Status
Do 7	Ch7 Output	Di 7	Ch7 Output Completion Status
Do 8	Ch8 Output	Di 8	Ch8 Output Completion Status
Do 9	Ch9 Output	Di 9	Ch9 Output Completion Status
Do 10	Ch10 Output	Di 10	Ch10 Output Completion Status
Do 11	Ch11 Output	Di 11	Ch11 Output Completion Status
Do 12	Ch12 Output	Di 12	Ch12 Output Completion Status
Do 13	Ch13 Output	Di 13	Ch13 Output Completion Status
Do 14	Ch14 Output	Di 14	Ch14 Output Completion Status
Do 15	Ch15 Output	Di 15	Ch15 Output Completion Status
Do 16	Ch16 Output	Di 16	Ch16 Output Completion Status



DATA ASSIGNMENT

■ Do 16 DATA

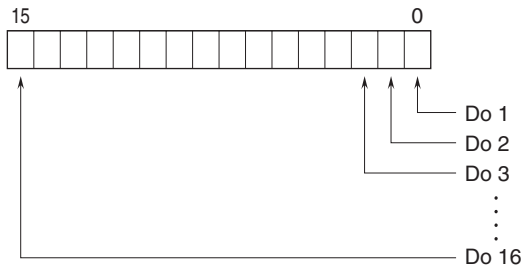

Note. For 8-bit length ON/OFF control mode, Do 9 through Do 16 are unavailable.

■ Di 16 DATA

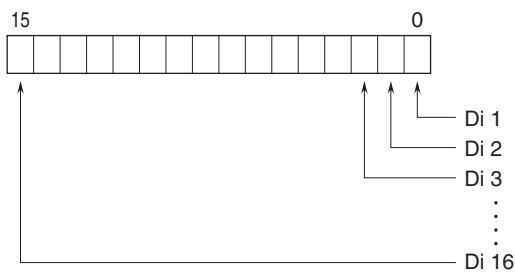

Note. Di data is not practical discrete input data. It is "output completion status" internal data.

EXTERNAL DIMENSIONS & TERMINAL ASSIGNMENTS unit: mm (inch)

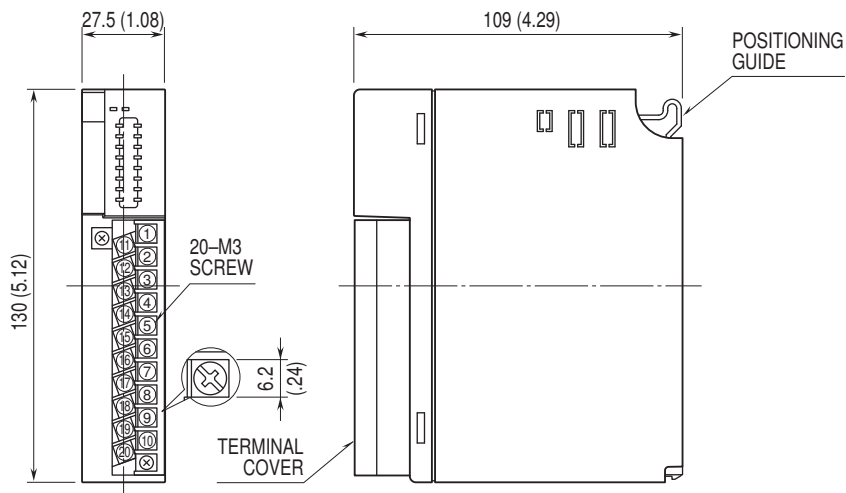

SCHEMATIC CIRCUITRY & CONNECTION DIAGRAM

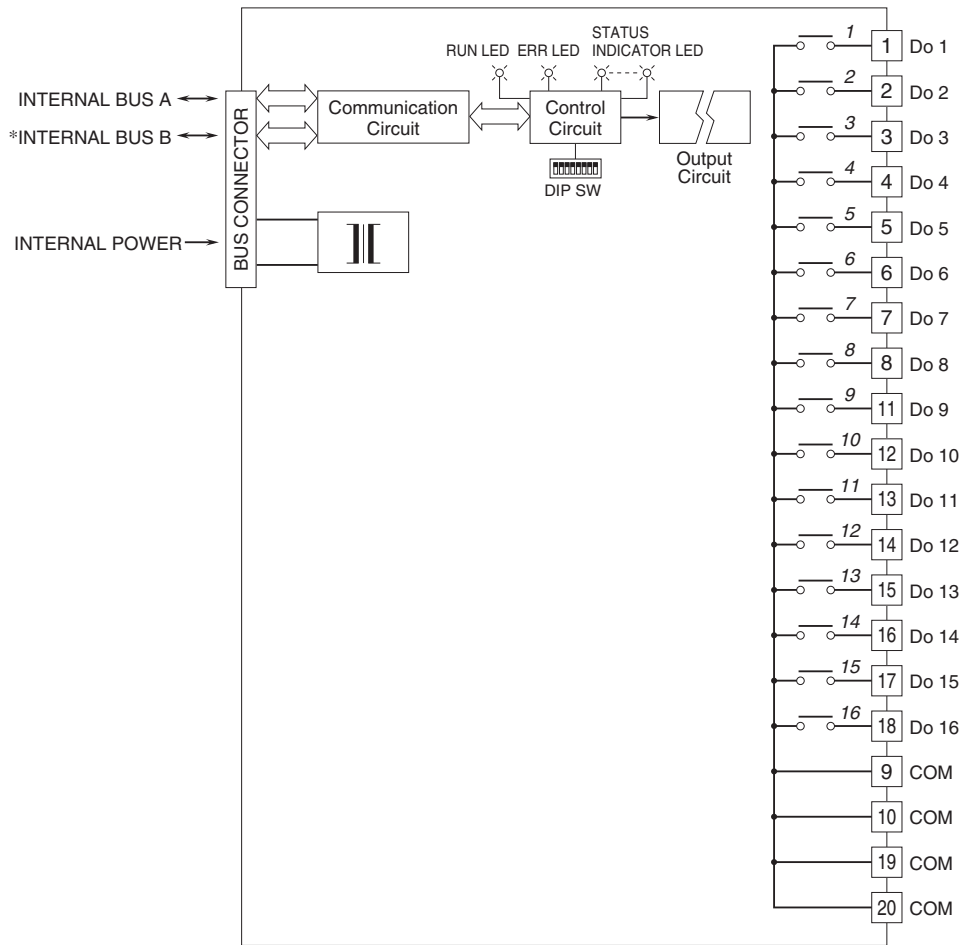

Numbers in italic indicate LED No.s assigned to the front panel LEDs.
 *For dual redundant communication.



Specifications are subject to change without notice.

