

Space-saving Plug-in Signal Conditioners H-UNIT

INPUT LOOP POWERED ISOLATOR

Functions & Features

- Loop-powered design eliminates output loop power supply
- 500 V DC input-to-output isolation
- 2 isolators housed in one enclosure
- 350 Ω output drive with 4 - 20 mA
- High-density mounting

Typical Applications

- Isolation between control room and field instrumentation, between telemetering system and input device
- Eliminates ground problems in existing systems thanks to easiness of application without requiring additional power wiring

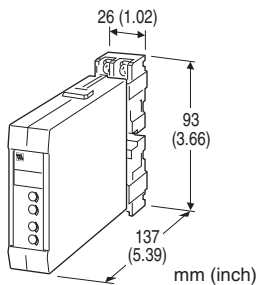

MODEL: HSN-[1][2]

ORDERING INFORMATION

- Code number: HSN-[1][2]
- Specify a code from below for each [1] and [2]. (e.g. HSN-2/Q)
- Specify the specification for option code /Q (e.g. /C01/S01)

[1] INPUT / OUTPUT

Single-channel

- 1: 4 - 20 mA DC / 1 - 5 V DC
 1H6: 10 - 50 mA DC / 1 - 5 V DC
 1AA: 4 - 20 mA DC / 4 - 20 mA DC
 1HA: 10 - 50 mA DC / 4 - 20 mA DC

Dual-channel

- 2: 4 - 20 mA DC / 1 - 5 V DC
 2H6: 10 - 50 mA DC / 1 - 5 V DC
 2AA: 4 - 20 mA DC / 4 - 20 mA DC
 2HA: 10 - 50 mA DC / 4 - 20 mA DC

[2] OPTIONS

- blank: none
 /Q: With options (specify the specification)

SPECIFICATIONS OF OPTION: Q (multiple selections)

COATING (For the detail, refer to M-System's web site.)

- /C01: Silicone coating
 /C02: Polyurethane coating
 /C03: Rubber coating

TERMINAL SCREW MATERIAL

- /S01: Stainless steel

GENERAL SPECIFICATIONS

- Construction: Plug-in
 Connection: M3.5 screw terminals (torque 0.8 N·m)
 Screw terminal: Nickel-plated steel
 Housing material: Flame-resistant resin (black)
 Isolation: Input to output; between channels
 Zero adjustment (front)
 Voltage output: -5 to +5 %
 Current output: -0.5 to +0.5 %
 Span adjustment (front)
 Voltage output: 95 to 105 %
 Current output: 98.5 to 101.5 %

INPUT & OUTPUT

- Input 4 - 20 mA DC / Output 1 - 5 V DC
 Equivalent input impedance: Approx. 250 Ω with 20 mA input
 Operational range: 3 - 22 mA DC (Accuracy is assured within 4 - 22 mA)
 Load resistance: ≥ 50 kΩ
- Input 10 - 50 mA DC / Output 1 - 5 V DC
 Equivalent input impedance: Approx. 100 Ω with 50 mA input
 Operational range: 7 - 55 mA DC (Accuracy is assured within 8 - 55 mA)
 Load resistance: ≥ 50 kΩ
- Input 4 - 20 mA DC / Output 4 - 20 mA DC
 Equivalent input impedance: 230 Ω plus load resistance with 20 mA input
 Operational range: 3 - 22 mA DC (Accuracy is assured within 4 - 22 mA)
 Load resistance: 50 - 350 Ω (min. 50 Ω required for adequate operation)
- Input 10 - 50 mA DC / Output 4 - 20 mA DC
 Equivalent input impedance: 90 Ω + [load resistance × 0.16] with 50 mA input



Operational range: 7 – 55 mA DC

(Accuracy is assured within 8 – 55 mA)

Load resistance: 50 – 600 Ω (min. 50 Ω required for adequate operation)

•INPUT 4 – 20 mA DC / OUTPUT 1 – 5 V DC

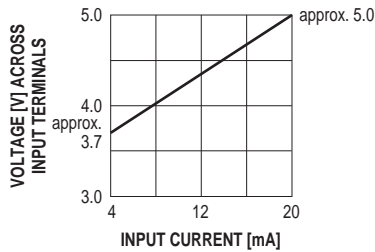

•INPUT 10 – 50 mA DC / OUTPUT 1 – 5 V DC

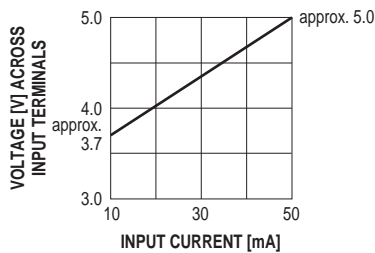

•INPUT 4 – 20mA DC / OUTPUT 4 – 20 mA DC

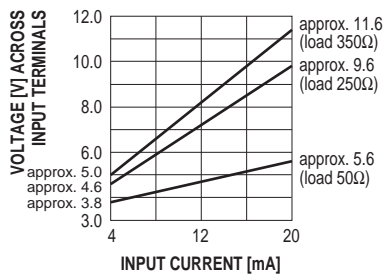

•INPUT 10 – 50 mA DC / OUTPUT 4 – 20 mA DC

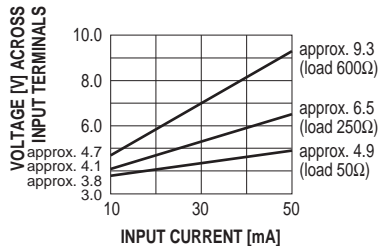

INSTALLATION

Operating temperature: -5 to +55°C (23 to 131°F)

Operating humidity: 30 to 90 %RH (non-condensing)

Mounting: Surface or DIN rail; Standard Rack Mounting

Frame BX-16H available

Weight: 200 g (0.44 lbs)

PERFORMANCE in percentage of span

Accuracy: ±0.1 %

Temp. coefficient

Voltage output: ±0.015 %/°C (±0.008 %/°F)

Current output: ±0.02 %/°C (±0.01 %/°F)

Response time

Voltage output: ≤ 0.5 sec. (0 – 90 %)

Current output: Approx. 15 msec. (0 – 90 %)

Load effect (current output)

4 – 20 mA input: 0.015 %/Ω (50 – 150 Ω)

0.003 %/Ω (150 – 350 Ω)

10 – 50 mA input: 0.015 %/Ω (50 – 100 Ω)

0.003 %/Ω (100 – 600 Ω)

(The unit is calibrated with 250 Ω load at the factory.)

Insulation resistance: ≥ 100 MΩ with 500 V DC

Dielectric strength:

500 V AC @1 minute (input to output)

1500 V AC @1 minute (between channels)

1500 V AC @1 minute (input or output to ground)



EXTERNAL DIMENSIONS & TERMINAL ASSIGNMENTS unit: mm (inch)

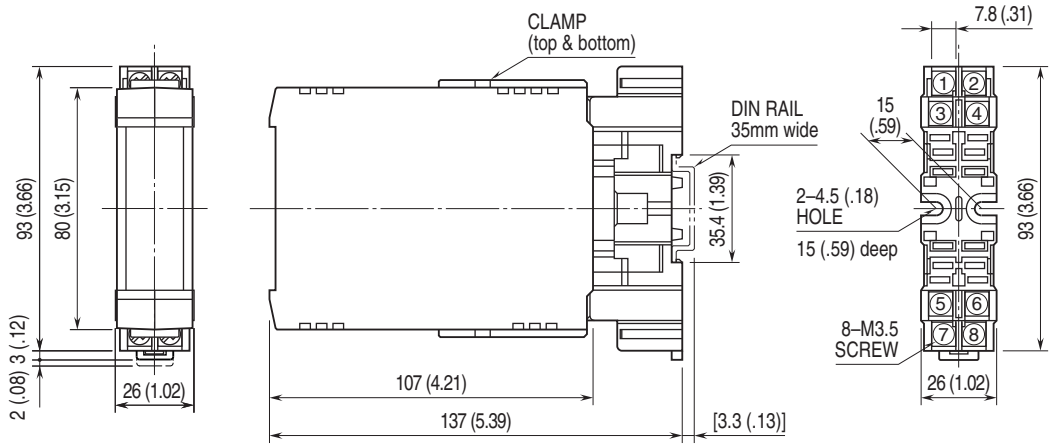

•When mounting, no extra space is needed between units.

SCHEMATIC CIRCUITRY & CONNECTION DIAGRAM

Remark: For the single-channel model, the terminals 3 - 4 and 7 - 8 are used.

■ VOLTAGE OUTPUT

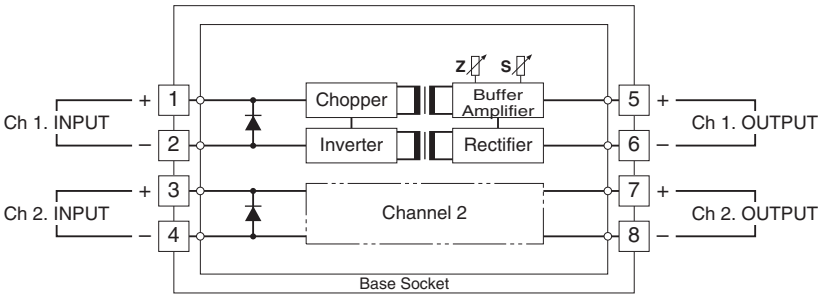

■ CURRENT OUTPUT

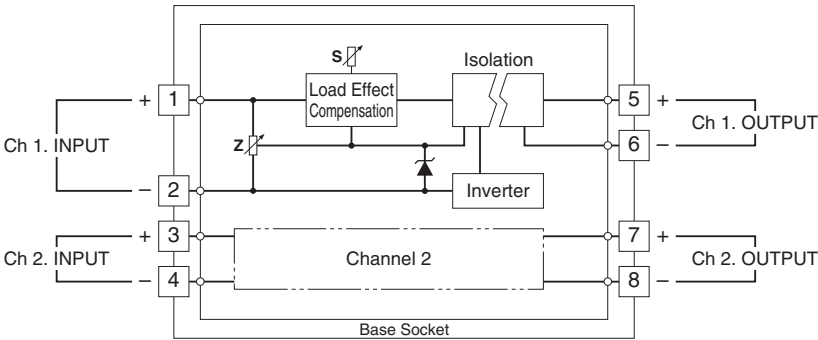

 Specifications are subject to change without notice.

