

Bargraph Indicators 48N Series

BARGRAPH INDICATING ALARM

(with 4-digit digital meter; RTD input)

Functions & Features

- Displays a process variable in graphic bargraph of 101 LED segments
- Clear 4-digit digital meter
- Provides max. 4 alarm contact outputs
- Multi-color indicator
- Linearization and burnout
- LED brightness adjustment
- IP65 front cover
- Scale plate is easily replaced
- Separable terminal block

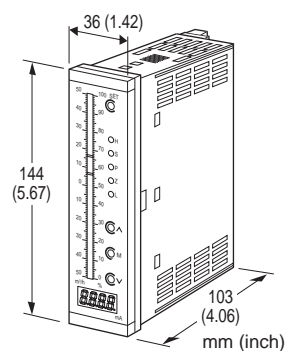

MODEL: 48NDR-[1][2][3]-[4][5]

ORDERING INFORMATION

- Code number: 48NDR-[1][2][3]-[4][5]
- Specify a code from below for each [1] through [5].
(e.g. 48NDR-424-R/CE/D/BL/Q)
- Temperature range (e.g. 0 - 200 °C)
- Bargraph scale (e.g. 0 - 100 %) (See 'Scale Plate.')
- Digital indicator scale (e.g. 0.0 - 200.0)
- Specify the specification for option code /Q
(e.g. /SET)

[1] ALARM OUTPUT

- 0: None
- 2: 2 points
- 4: 4 points

[2] BAR LED COLOR

- R: Red
- Y: Amber
- G: Green

B: Blue

- 1: Multi-color (red, orange and green), Pattern 1
(See 'External View.')
- 2: Multi-color (red, orange and green), Pattern 2
(See 'External View.')

[3] INPUT RTD (2- or 3-wire)

- 1: JPt 100 (JIS'89)
(Usable range: -200 to +500°C, -328 to +932°F; min.span: 50°C, 90°F)
 - 3: Pt 100 (JIS'89)
(Usable range: -200 to +650°C, -328 to +1202°F; min.span: 50°C, 90°F)
 - 4: Pt 100 (JIS'97, IEC)
(Usable range: -200 to +850°C, -328 to +1562°F; min.span: 50°C, 90°F)
 - 5: Pt 50 Ω (JIS'81)
(Usable range: -200 to +500°C, -328 to +932°F; min.span: 100°C, 180°F)
 - 6: Ni 508.4 Ω
(Usable range: -50 to +200°C, -58 to +392°F; min.span: 30°C, 54°F)
- Note: Consult M-System for 2-wire RTD

[4] POWER INPUT

AC Power

- M: 85 - 264 V AC (Operational voltage 85 - 264 V, 50/60 Hz
(CE marking not available)
- M2: 100 - 240 V AC (Operational voltage range 85 - 264 V, 50/60 Hz)

DC Power

- R: 24 V DC
(Operational voltage range 24 V ±15 %, ripple 10 %p-p max.)

[5] OPTIONS (multiple selections)

Standards & Approvals

- blank: Without CE
- /CE: CE marking

Bezels

- blank: Bezels for M-System's 48 Series panel cutout
- /D: Bezels for DIN panel cutout
- /F: Bezels for Fuji Electric's PAJ, PAK, PBA panel cutout

Burnout

- blank: Upscale burnout
- /BL: Downscale burnout

Other Options

- blank: none
- /Q: Option other than the above (specify the specification)

SPECIFICATIONS OF OPTION: Q

EX-FACTORY SETTING

- /SET: Preset according to the Ordering Information Sheet
(No. ESU-9436)



BEZEL OPTION

Bezels are used to adapt the 48N Series to an existing panel cutout. In order to replace M-System's 48 Series products, use the one attached to the 48N Series as standard. When the existing panel is cut according to DIN standard, specify '/D' suffix code.

For a new installation, no bezel is required. Please refer to 'Mounting Requirement' and mount the 48N directly. Ingress protection is invalid when the 48N is mounted with a bezel, or when multiple modules are stacked side by side.

SPARE PARTS

- Scale plate

GENERAL SPECIFICATIONS

Construction: Panel flush mounting

Degree of protection: IP65; applicable to the front panel for single unit mounted according to the specified panel cutout

Connection: M3 separable screw terminal (torque 0.6 N·m)

Screw terminal: Nickel-plated steel

Housing material: Flame-resistant resin (black)

Isolation: Input to output to power

Zero adjustment: 0 - 10 % (front)

Span adjustment: 90 to 100 % (front)

Scale plate: Flame resistant resin (white scale & characters on black base)

H & L alarm output delay: 0 sec. (factory setting; fieldselectable between 0 and 15 sec. by 1 sec. increments)

Setpoint adjustment

2 points:

H [L setpoint] to 100 %

L 0 to [H setpoint]

or No alarm trip

4 points:

HH [H setpoint] to 100 %

H [L setpoint] to [HH setpoint]

L [LL setpoint] to [H setpoint]

LL 0 to [L setpoint]

or No alarm trip

Alarm deadband (hysteresis): 1 %

Burnout: Upscale standard; downscale optional.

The 100 % position bargraph segment and 115 % value of the digital meter blink with upscale burnout; the 0 % position bargraph segment and -15 % value of the digital meter blink with downscale burnout.

Linearization: Standard

Setting: (Front button)

- Zero and span adjustments
- Alarm setpoint
- Others

(Refer to the instruction manual for details)

Read rate: 10/s

Moving average sample number: 4 (factory setting; field selectable among 1, 2, 4, 8 or 16)

LED brightness adjustment: 7 levels

■ BARGRAPH

LED: 101-segment LED, 100 mm (3.96") long, 3.00 mm (.12") wide

Display range: 0 to 100 (scaling function not available) (0 % or 100 % position bar blinks when over range)

Scale: Two different scales available for single bargraph

Characters: Max. 4 characters including decimal point and negative sign

Divisions: Min. 22, max. 100

Engineering unit: Max. 6 characters

■ DIGITAL DISPLAYS

LED: 7-segment red LED, character 8 mm (.31") high

Number of digits: 4 digits

Setting range: -1999 to 9999

(Min. 3 significant digits)

Minimum scale value: 100 (3 digits, the decimal point position disregarded)

Scaled range: The range between -1999 to 9999 and -15 to +115 % of input span

(The indicator blinks when the input is out of the range)

Decimal point position: 10^{-1} , 10^{-2} , 10^{-3} or none

Zero indication: Higher-digit zeros are suppressed

Engineering unit: Max. 6 characters on scale plate

INPUT SPECIFICATIONS

Maximum leadwire resistance: 200 Ω per wire (3-wire)

Sensing current: ≤ 1 mA

OUTPUT SPECIFICATIONS

■ **Alarm Output:** Relay contact

Rated load: 250 V AC @1 A ($\cos \phi = 1$)

30 V DC @5 A (resistive load)

Maximum switching voltage: 250 V AC, 220 V DC

Maximum switching power: 380 VA, 150 W

Minimum load: 5 V DC @100 mA

Mechanical life: $\geq 5 \times 10^8$ cycles (rate 180 cycles/min.)



Alarm Trip Operation

Terminal No. in parentheses

• Alarm Suffix Code 2

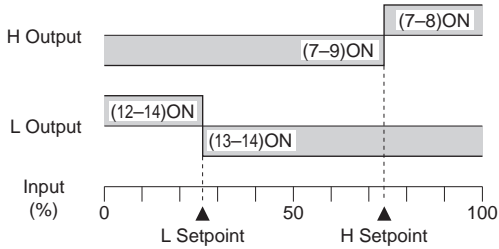

Terminals 7 – 9, 13 – 14 turn on at a loss of power.

• Alarm Suffix Code 4

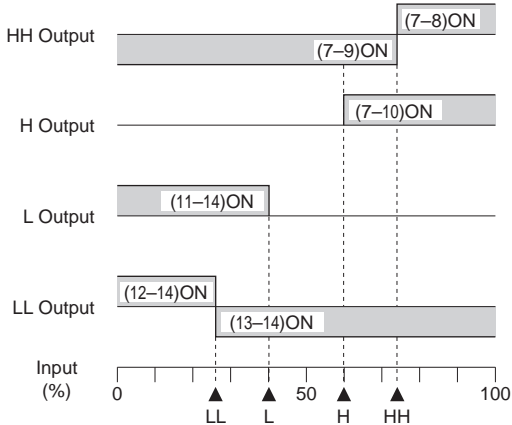

Terminals 7 – 9, 13 – 14 turn on at a loss of power.

Dielectric strength: 2000 V AC @1 minute (input to output to power to ground)

STANDARDS & APPROVALS

CE conformity:

EMC Directive (2004/108/EC)

EMI EN 61000-6-4: 2007/A1: 2011

EMS EN 61000-6-2: 2005

Low Voltage Directive (2006/95/EC)

EN 61010-1: 2010

Measurement Category II

Pollution degree 2

Input to output to power – Reinforced insulation (300 V)

INSTALLATION

Power Consumption

•AC:

Approx. 5.5 VA at 100 V with max. load

Approx. 7 VA at 200 V with max. load

Approx. 8 VA at 264 V with max. load

•DC

Approx. 3.5 W at 20.4 V with max. load

Approx. 3.5 W at 24 V with max. load

Approx. 3.5 W at 27.6 V with max. load

Operating temperature: -5 to +55°C (23 to 131°F)

Operating humidity: 30 to 90 %RH (non-condensing)

Mounting: Panel flush mounting

Weight: 300 g (0.66 lb)

PERFORMANCE in percentage of span

Accuracy

Bargraph: $\pm 1\%$ ± 1 digit

Digital indicator: $\pm 0.5\%$ ± 1 digit

Temp. coefficient: $\pm 0.015\%$ of FS/°C ($\pm 0.008\%$ of FS/°F)

Response time: ≤ 0.5 sec.

(moving average sample number set to 4)

Burnout response: ≤ 10 sec.

Insulation resistance: ≥ 100 M Ω with 500 V DC



幸託有限公司
XIN TOP CORPORATION

TEL : (02)2598-1199

FAX : (02)2596-2331

E-mail : info@xintop.com

Website : www.xintop.com

SCALE PLATE

■ WHAT MUST BE SPECIFIED WHEN ORDERING

Please specify the bargraph scale range and engineering unit. The overall scale plate design including the number of divisions, division line length, character font is determined by M-System.

[Example] : Bargraph range 0 to 300°C

Bargraph scale range: 0 – 300

Engineering unit for the bargraph: °C

■ TYPES OF DIVISIONS

Five (5) types of divisions are used depending upon the scale span, which determined by the following equation:

$$\text{Scale Span} = (\text{Max. range value} - \text{Min. range value}) \times 10^n$$

where n = integer (used to limit the calculated scale span to the minimum of 1.1, below 11.0.)

The number of divisions is automatically determined by the scale span.

• Type 1: 1.1 Scale Span < 1.3

Number of divisions: 22 to 25.9

Scale: Starts at 0, increments by 0.02 / 0.2 / 2 / 20 / 200. Min. and max. values indicated. 4 digits including negative sign and decimal point.

Division lines: Long, Short, Medium, Short, Long (4 divisions repeated)

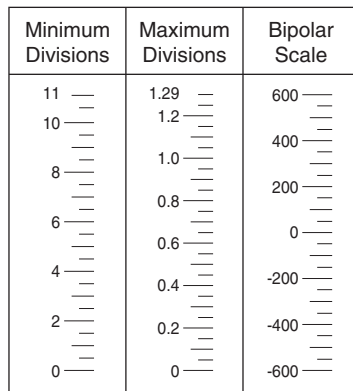

• Type 3: 2.0 Scale Span < 2.6

Number of divisions: 40 to 51.9

Scale: Starts at 0, increments by 0.05 / 0.5 / 5 / 50 / 500. Min. and max. values indicated. 4 digits including negative sign and decimal point.

Division lines: Long, Short, Medium, Short, Medium, Short, Medium, Short, Medium, Short, Long (10 divisions repeated)

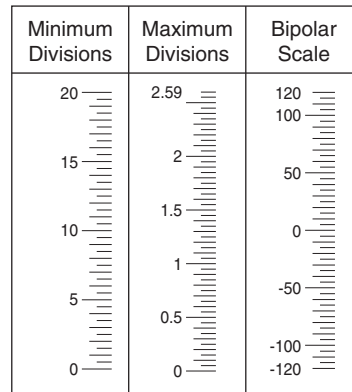

• Type 2: 1.3 Scale Span < 2.0

Number of divisions: 26 to 39.9

Scale: Starts at 0, increments by 0.03 / 0.3 / 3 / 30 / 300. Min. and max. values indicated. 4 digits including negative sign and decimal point.

Division lines: Long, Short, Medium, Short, Medium, Short, Long (6 divisions repeated)

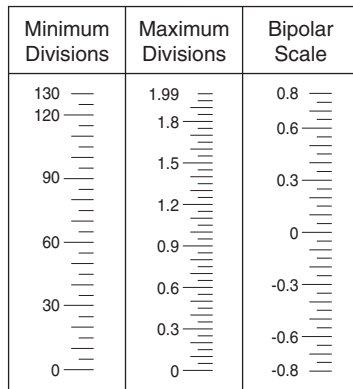

• Type 4: 2.6 Scale Span < 5.5

Number of divisions: 26 to 54.9

Scale: Starts at 0, increments by 0.05 / 0.5 / 5 / 50 / 500. Min. and max. values indicated. 4 digits including negative sign and decimal point.

Division lines: Long, Medium, Medium, Medium, Medium, Long (5 divisions repeated)

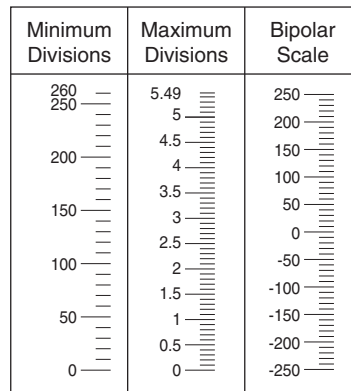

• **Type 5: 5.5 Scale Span < 11.0**

Number of divisions: 27.5 to 54.9

Scale: Starts at 0, increments by 0.01 / 0.1 / 1 / 10 / 100 / 1000. Min. and max. values indicated.

4 digits including negative sign and decimal point.

Division lines: Long, Medium, Medium, Medium, Medium, Long (5 divisions repeated)

Minimum Divisions	Maximum Divisions	Bipolar Scale
550	10.9	0.5
500	10	0.4
	9	0.3
400	8	0.2
	7	0.1
300	6	0
	5	-0.1
200	4	-0.2
	3	-0.3
100	2	-0.4
	1	-0.4
0	0	-0.5

[Example] : Bargraph range 0 to 300°C (Type 4) for left
 Bargraph range 0 to 100 % (Type 5) for right
 Digital indicator range 0 to 300°C

Left scale range: 0 – 300

Left scale unit (bargraph): °C

Right scale range: 0 – 100

Right scale unit (bargraph): %

Digital indicator unit: °C

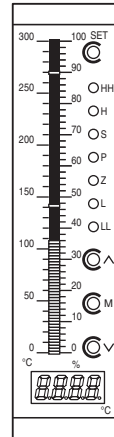

EXTERNAL VIEW

■ ALARM SUFFIX CODE 0: None

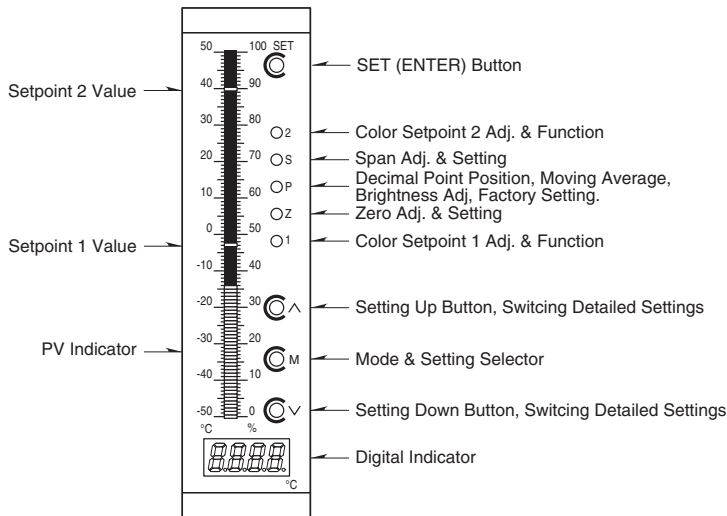

Setpoint 1 or 2 provided only for the multi-color bar type.

• Bar Color Patterns

Pattern 1 (model suffix code 1)

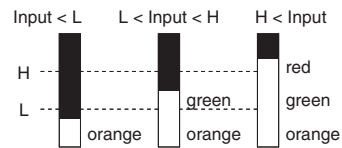

Pattern 2 (model suffix code 2)

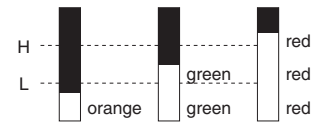

■ ALARM SUFFIX CODE 2: 2 points

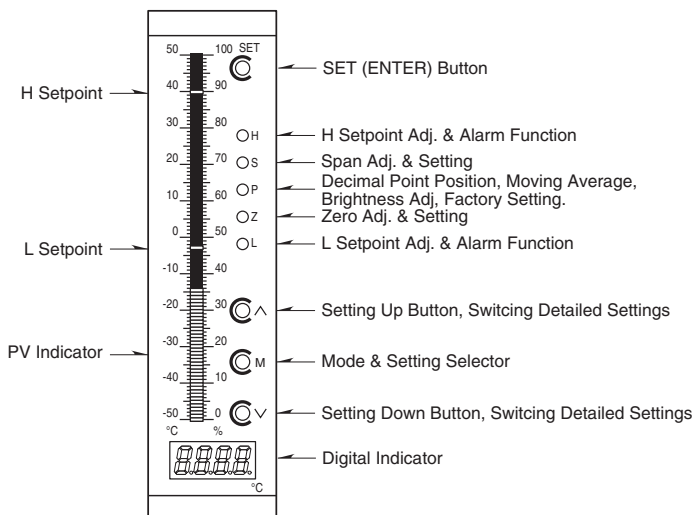

■ ALARM SUFFIX CODE 4: 4 points

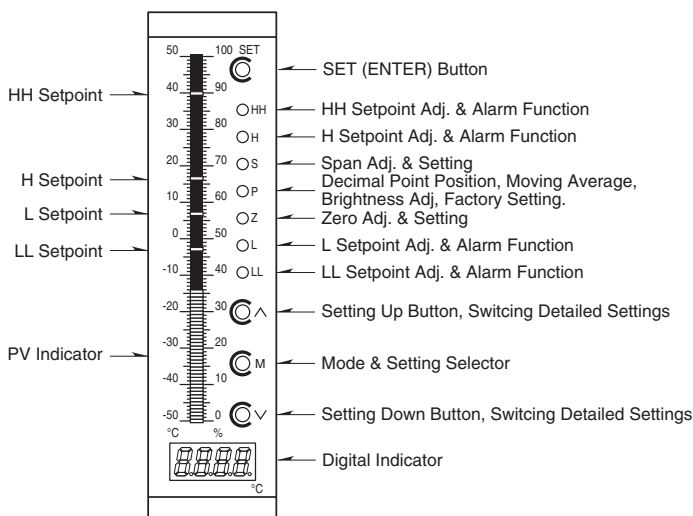

DIMENSIONS unit: mm (inch)

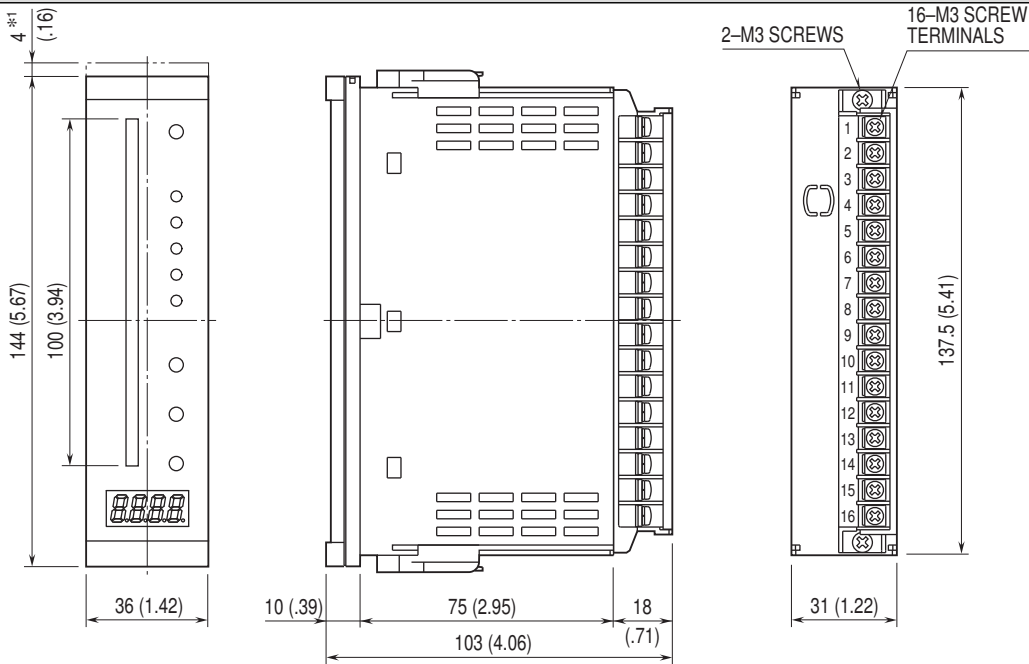

STANDARD BEZEL *2

OPTION /D BEZEL *3

OPTION /F BEZEL *4

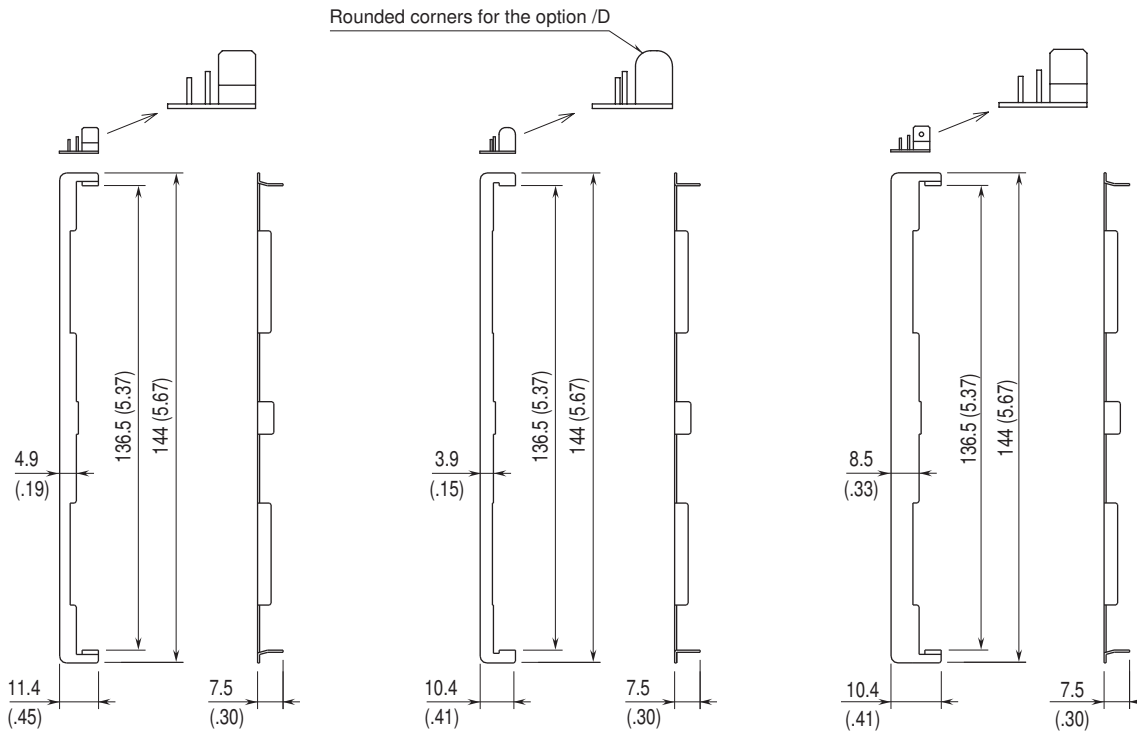

- *1. Space required when replacing the scale plate.
- *2. Used for the existing panel cutout of M-System 48 Series (38 × 139.5 mm).
- *3. Used for the existing DIN panel cutout (33 × 138 mm)
- *4. Used for the existing panel cutout of Fuji Electric PAJ, PAK, PBA (44 × 138 mm), etc.



PANEL CUTOUT unit: mm

■ SINGLE MOUNTING (ingress protection)

■ CLUSTERED MOUNTING (no ingress protection)

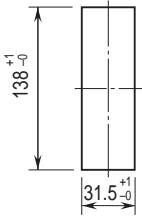

Panel thickness: 1.6 – 8.0 mm

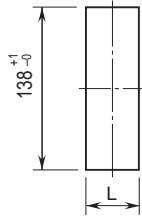

Panel thickness: 1.6 – 8.0 mm

$$L = \{31.5 + 36 \times (N - 1)\}^{+1}_{-0}$$

(N : number of units)

Note 1. Observe at the minimum of 3 cm above and below the units for heat dissipation.

Note 2. No bezel is needed when the panel is cut according to the left drawings.



SCHEMATIC CIRCUITRY & CONNECTION DIAGRAM

■ ALARM SUFFIX CODE 0: None

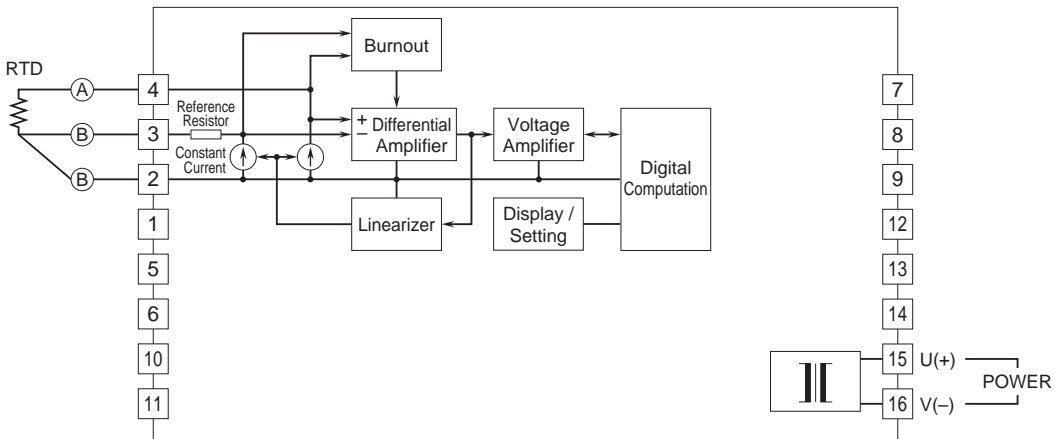

■ ALARM SUFFIX CODE 2: 2 points

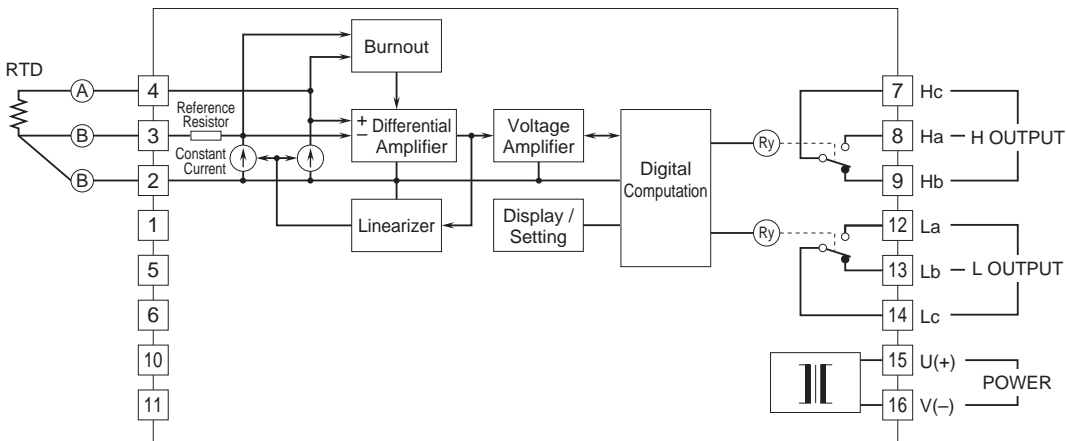

■ ALARM SUFFIX CODE 4: 4 points

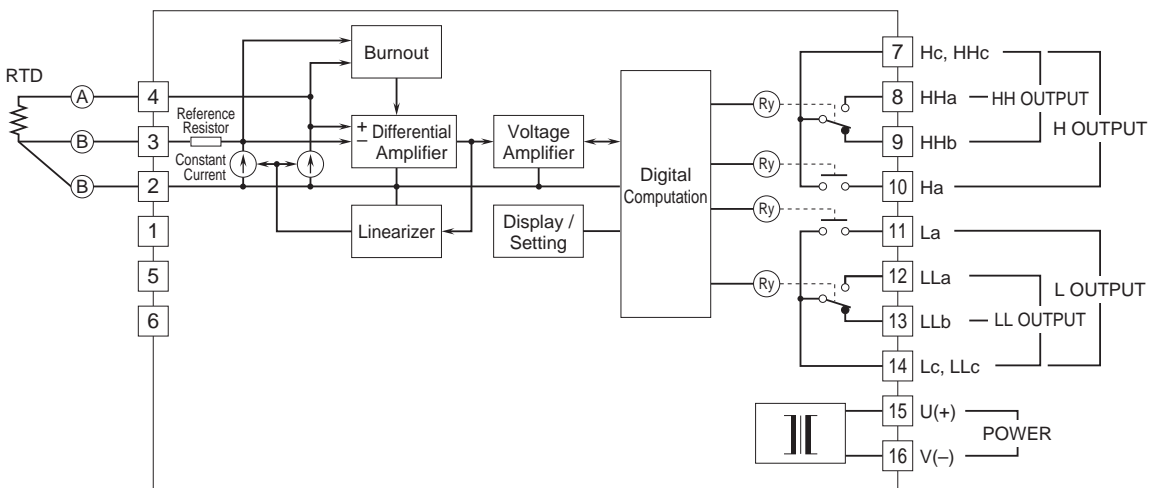

■ Relay Protection

• AC Powered

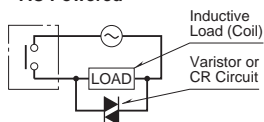

• DC Powered

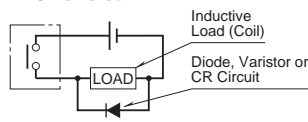



Specifications are subject to change without notice.

