

## Bargraph Indicators 48N Series

(See 'External View.')

### BARGRAPH INDICATING ALARM

(RTD input)

#### Functions & Features

- Displays a process variable in graphic bargraph of 101 LED segments
- Provides max. 4 alarm contact outputs
- Multi-color indicator
- Linearization and burnout
- IP65 front cover
- Scale plate is easily replaced
- Separable terminal block

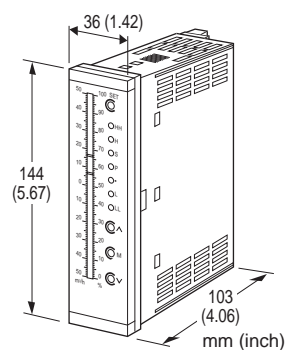

### MODEL: 48NAR-[1][2][3][4]-[5][6]

#### ORDERING INFORMATION

- Code number: 48NAR-[1][2][3][4]-[5][6]
- Specify a code from below for each [1] through [6].  
(e.g. 48NAR-42V4-R/CE/D/BL/Q)
- Temperature range (e.g. 0 - 200 °C)
- Bargraph scale (e.g. 0 - 100 %) (See 'Scale Plate.')
- Specify the specification for option code /Q  
(e.g. /SET)

#### [1] ALARM OUTPUT

- 2: 2 points
- 4: 4 points

#### [2] BAR LED COLOR

- R: Red
- Y: Amber
- G: Green
- B: Blue
- 1: Multi-color (red, orange and green), Pattern 1  
(See 'External View.')
- 2: Multi-color (red, orange and green), Pattern 2

#### [3] MOUNTING DIRECTION

- V: Vertical
- H: Horizontal

#### [4] INPUT RTD (2- or 3-wire)

- 1: JPt 100 (JIS'89)  
(Usable range: -200 to +500°C, -328 to +932°F; min.span: 50°C, 90°F)
  - 3: Pt 100 (JIS'89)  
(Usable range: -200 to +650°C, -328 to +1202°F; min.span: 50°C, 90°F)
  - 4: Pt 100 (JIS'97, IEC)  
(Usable range: -200 to +850°C, -328 to +1562°F; min.span: 50°C, 90°F)
  - 5: Pt 50 Ω (JIS'81)  
(Usable range: -200 to +500°C, -328 to +932°F; min.span: 100°C, 180°F)
  - 6: Ni 508.4 Ω  
(Usable range: -50 to +200°C, -58 to +392°F; min.span: 30°C, 54°F)
- Note: Consult M-System for 2-wire RTD

#### [5] POWER INPUT

- AC Power**
- M: 85 - 264 V AC (Operational voltage 85 - 264 V, 50/60 Hz  
(CE marking not available)
- M2: 100 - 240 V AC (Operational voltage range 85 - 264 V, 50/60 Hz)
- DC Power**
- R: 24 V DC  
(Operational voltage range 24 V ±15 %, ripple 10 %p-p max.)

#### [6] OPTIONS (multiple selections)

##### Standards & Approvals

- blank: Without CE
- /CE: CE marking

##### Bezels

- blank: Bezels for M-System's 48 Series panel cutout
- /D: Bezels for DIN panel cutout
- /F: Bezels for Fuji Electric's PAJ, PAK, PBA panel cutout

##### Burnout

- blank: Upscale burnout
- /BL: Downscale burnout

##### Other Options

- blank: none
- /Q: Option other than the above (specify the specification)

#### SPECIFICATIONS OF OPTION: Q

##### EX-FACTORY SETTING

- /SET: Preset according to the Ordering Information Sheet  
(No. ESU-9437)



## BEZEL OPTION

Bezels are used to adapt the 48N Series to an existing panel cutout. In order to replace M-System's 48 Series products, use the one attached to the 48N Series as standard. When the existing panel is cut according to DIN standard, specify '/D' suffix code.

For a new installation, no bezel is required. Please refer to 'Mounting Requirement' and mount the 48N directly. Ingress protection is invalid when the 48N is mounted with a bezel, or when multiple modules are stacked side by side.

## SPARE PARTS

- Scale plate

## GENERAL SPECIFICATIONS

**Construction:** Panel flush mounting

**Degree of protection:** IP65; applicable to the front panel for single unit mounted according to the specified panel cutout

**Connection:** M3 screw terminals (torque 0.6 N·m)

**Screw terminal:** Nickel-plated steel

**Housing material:** Flame-resistant resin (black)

**Isolation:** Input to output to power

**Zero adjustment:** 0 - 10 % (front)

**Span adjustment:** 90 to 100 % (front)

**Scale plate:** Flame resistant resin (white scale & characters on black base)

**Setpoint adjustment**

**2 points:**

H [L setpoint] to 100 %

L 0 to [H setpoint]

or No alarm trip

**4 points:**

HH [H setpoint] to 100 %

H [L setpoint] to [HH setpoint]

L [LL setpoint] to [H setpoint]

LL 0 to [L setpoint]

or No alarm trip

**Alarm deadband (hysteresis):** 1 %

**Burnout:** Upscale standard; downscale optional.

The highest bargraph segment blinks with upscale burnout; the lowest blinks with downscale burnout.

**Linearization:** Standard

**Setting:** (Front button)

- Zero and span adjustments
- Alarm setpoint
- Others

(Refer to the instruction manual for details)

■ **BARGRAPH**

**LED:** 101-segment LED, 100 mm (3.96") long, 3.00 mm (.12") wide

**Display range:** 0 to 100 (scaling function not available)

**Scale:** Two different scales available for single bargraph

**Characters:** Max. 4 characters including decimal point and negative sign

**Divisions:** Min. 22, max. 100

**Engineering unit:** Max. 6 characters

## INPUT SPECIFICATIONS

**Maximum leadwire resistance:** 200 Ω per wire (3-wire)

**Sensing current:** ≤ 1 mA

## OUTPUT SPECIFICATIONS

■ **Alarm Output:** Relay contact

**Rated load:** 250 V AC @1 A (cos φ = 1)

30 V DC @5 A (resistive load)

**Maximum switching voltage:** 250 V AC, 220 V DC

**Maximum switching power:** 380 VA, 150 W

**Minimum load:** 5 V DC @100 mA

**Mechanical life:** ≥ 5 × 10<sup>8</sup> cycles (rate 180 cycles/min.)

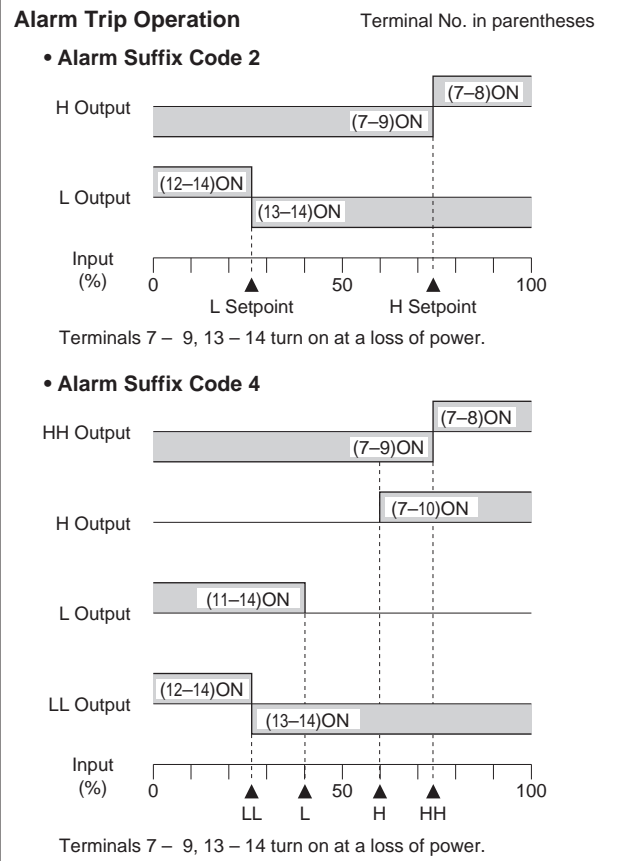

## INSTALLATION

**Power Consumption**

• **AC:**

Approx. 5.5 VA at 100 V with max. load

Approx. 7 VA at 200 V with max. load

Approx. 8 VA at 264 V with max. load



## •DC

Approx. 3.5 W at 20.4 V with max. load

Approx. 3.5 W at 24 V with max. load

Approx. 3.5 W at 27.6 V with max. load

**Operating temperature:** -5 to +55°C (23 to 131°F)

**Operating humidity:** 30 to 90 %RH (non-condensing)

**Mounting:** Panel flush mounting

**Weight:** 300 g (0.66 lb)

## PERFORMANCE in percentage of span

**Accuracy:**  $\pm 1\%$   $\pm 1$  digit

**Temp. coefficient:**  $\pm 0.015\%$  of FS/°C ( $\pm 0.008\%$  of FS/°F)

**Response time:**  $\leq 0.5$  sec.

**Burnout response:**  $\leq 10$  sec.

**Insulation resistance:**  $\geq 100\text{ M}\Omega$  with 500 V DC

**Dielectric strength:** 2000 V AC @1 minute (input to output to power to ground)

## STANDARDS & APPROVALS

### CE conformity:

EMC Directive (2004/108/EC)

EMI EN 61000-6-4: 2007

EMS EN 61000-6-2: 2005

Low Voltage Directive (2006/95/EC)

EN 61010-1: 2001

Installation Category II

Pollution Degree 2

Input to output to power - Reinforced insulation (300 V)



## SCALE PLATE

### ■ WHAT MUST BE SPECIFIED WHEN ORDERING

Please specify the bargraph scale range and engineering unit. The overall scale plate design including the number of divisions, division line length, character font is determined by M-System.

[Example] : Bargraph range 0 to 300°C

Bargraph scale range: 0 – 300

Engineering unit for the bargraph: °C

### ■ TYPES OF DIVISIONS

Five (5) types of divisions are used depending upon the scale span, which determined by the following equation:

$$\text{Scale Span} = (\text{Max. range value} - \text{Min. range value}) \times 10^n$$

where n = integer (used to limit the calculated scale span to the minimum of 1.1, below 11.0.)

The number of divisions is automatically determined by the scale span.

#### • Type 1: 1.1 Scale Span < 1.3

Number of divisions: 22 to 25.9

Scale: Starts at 0, increments by 0.02 / 0.2 / 2 / 20 / 200. Min. and max. values indicated. 4 digits including negative sign and decimal point.

Division lines: Long, Short, Medium, Short, Long (4 divisions repeated)

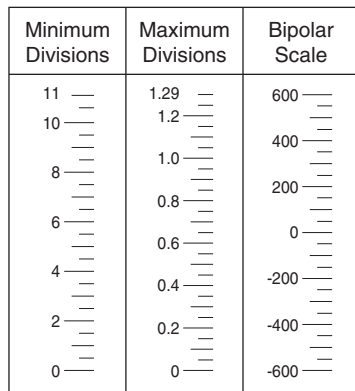

#### • Type 3: 2.0 Scale Span < 2.6

Number of divisions: 40 to 51.9

Scale: Starts at 0, increments by 0.05 / 0.5 / 5 / 50 / 500. Min. and max. values indicated. 4 digits including negative sign and decimal point.

Division lines: Long, Short, Medium, Short, Medium, Short, Medium, Short, Medium, Short, Long (10 divisions repeated)

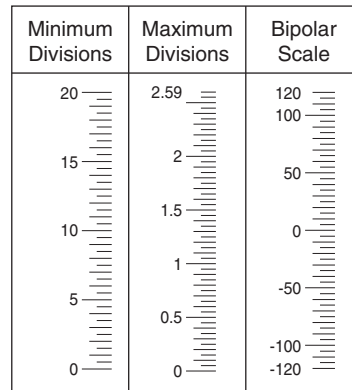

#### • Type 2: 1.3 Scale Span < 2.0

Number of divisions: 26 to 39.9

Scale: Starts at 0, increments by 0.03 / 0.3 / 3 / 30 / 300. Min. and max. values indicated. 4 digits including negative sign and decimal point.

Division lines: Long, Short, Medium, Short, Medium, Short, Long (6 divisions repeated)

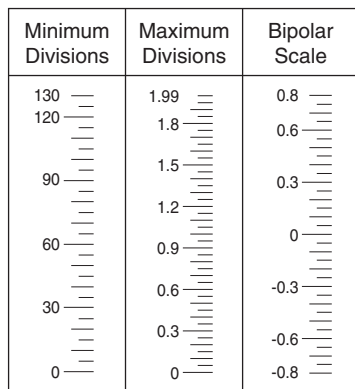

#### • Type 4: 2.6 Scale Span < 5.5

Number of divisions: 26 to 54.9

Scale: Starts at 0, increments by 0.05 / 0.5 / 5 / 50 / 500. Min. and max. values indicated. 4 digits including negative sign and decimal point.

Division lines: Long, Medium, Medium, Medium, Medium, Long (5 divisions repeated)

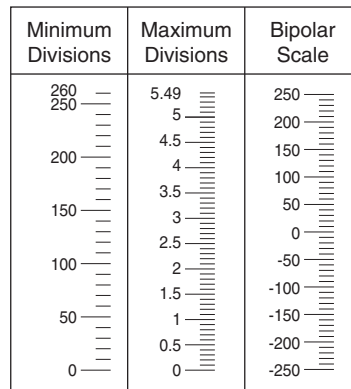

# MODEL: 48NAR

• **Type 5: 5.5 Scale Span < 11.0**

Number of divisions: 27.5 to 54.9  
 Scale: Starts at 0, increments by 0.01 / 0.1 / 1 / 10 / 100 / 1000. Min. and max. values indicated.  
 4 digits including negative sign and decimal point.  
 Division lines: Long, Medium, Medium, Medium, Medium, Long (5 divisions repeated)

[Example] : Bargraph range 0 to 300°C (Type 4) for left  
 Bargraph range 0 to 100 % (Type 5) for right  
 Left scale range: 0 – 300  
 Left scale unit (bargraph): °C  
 Right scale range: 0 – 100  
 Right scale unit (bargraph): %

Minimum Divisions	Maximum Divisions	Bipolar Scale
550	10.9	0.5
500	10	0.4
	9	0.3
400	8	0.2
	7	0.1
300	6	0
	5	-0.1
200	4	-0.2
	3	-0.3
100	2	-0.4
	1	-0.5
0	0	

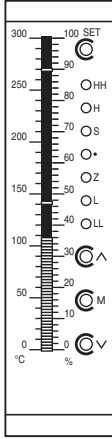

## EXTERNAL VIEW

### ALARM SUFFIX CODE 2: 2 points

#### Vertical Mounting

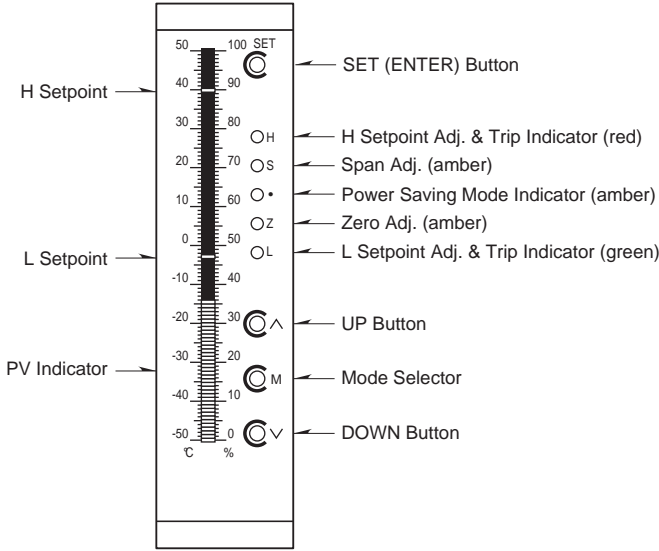

#### Horizontal Mounting

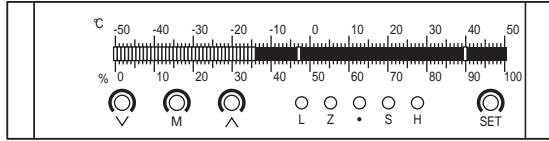

### ALARM SUFFIX CODE 4: 4 points

#### Vertical Mounting

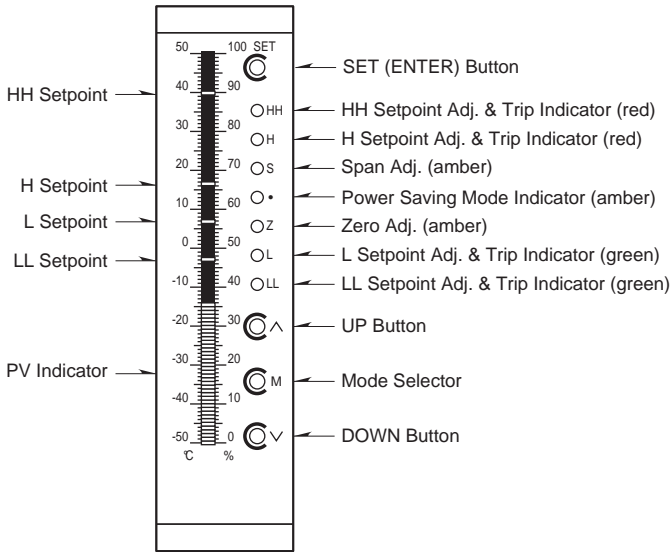

#### Horizontal Mounting

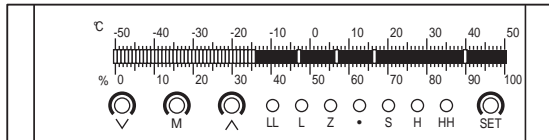

### Bar Color Patterns

#### Pattern 1 (model suffix code 1)

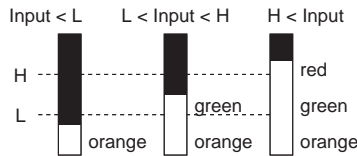

#### Pattern 2 (model suffix code 2)

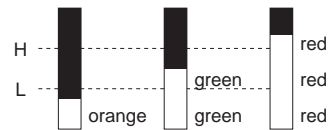

**DIMENSIONS unit: mm (inch)**

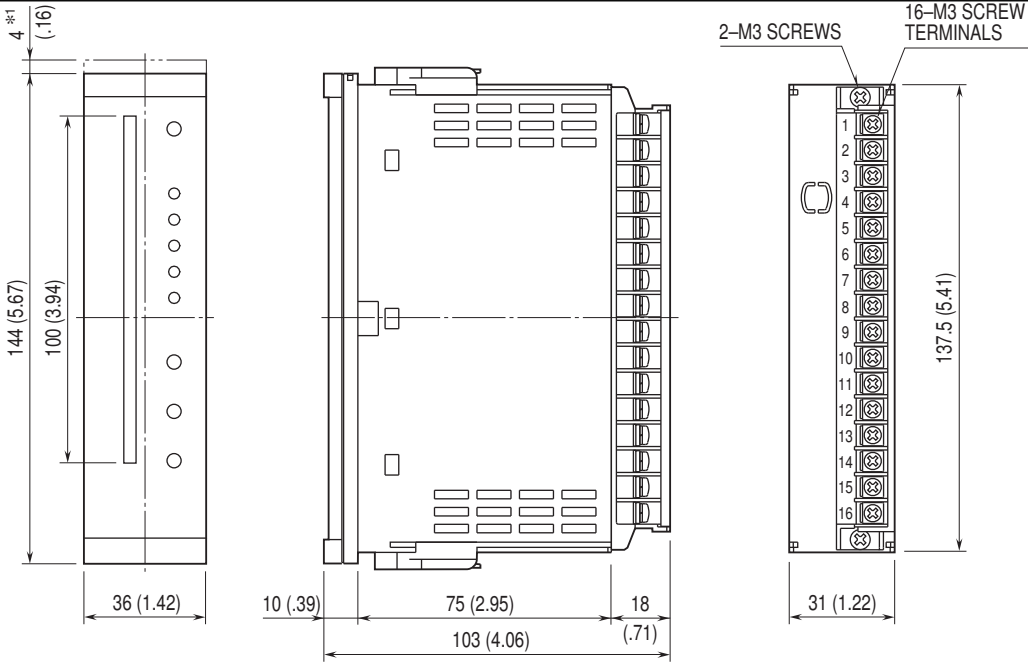

**STANDARD BEZEL** \*2

**OPTION /D BEZEL** \*3

**OPTION /F BEZEL** \*4

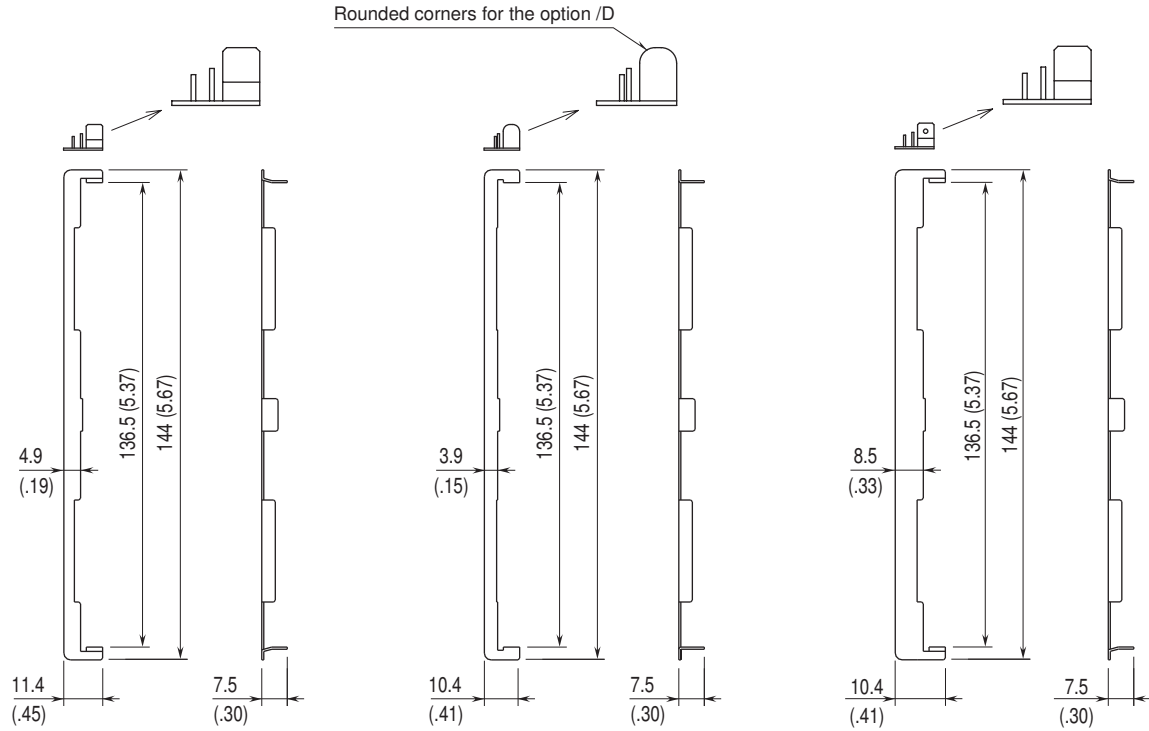

\*1. Space required when replacing the scale plate.  
 \*2. Used for the existing panel cutout of M-System 48 Series (38 × 139.5 mm).  
 \*3. Used for the existing DIN panel cutout (33 × 138 mm)  
 \*4. Used for the existing panel cutout of Fuji Electric PAJ, PAK, PBA (44 × 138 mm), etc.



## PANEL CUTOUT unit: mm

### ■ SINGLE MOUNTING (ingress protection)

#### • Vertical Mounting

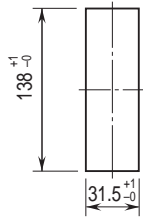

Panel thickness: 1.6 – 8.0 mm

#### • Horizontal Mounting

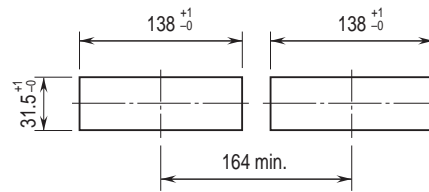

Panel thickness: 1.6 – 8.0 mm

### ■ CLUSTERED MOUNTING (no ingress protection)

#### • Vertical Mounting

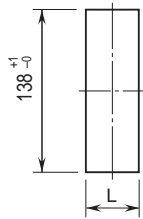

Panel thickness: 1.6 – 8.0 mm

$$L = \{31.5 + 36 \times (N - 1)\}_{-0}^{+1}$$

(N : number of units)

#### • Horizontal Mounting

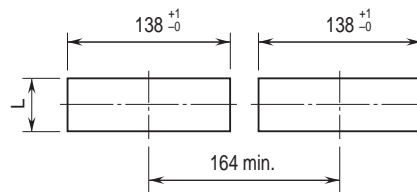

Panel thickness: 1.6 – 8.0 mm

$$L = \{31.5 + 36 \times (N - 1)\}_{-0}^{+1}$$

(N : number of units)

Note 1. Observe at the minimum of 3 cm above and below the units for heat dissipation.  
 Note 2. No bezel is needed when the panel is cut according to the above drawings.



**SCHEMATIC CIRCUITRY & CONNECTION DIAGRAM**

■ ALARM SUFFIX CODE 2: 2 points

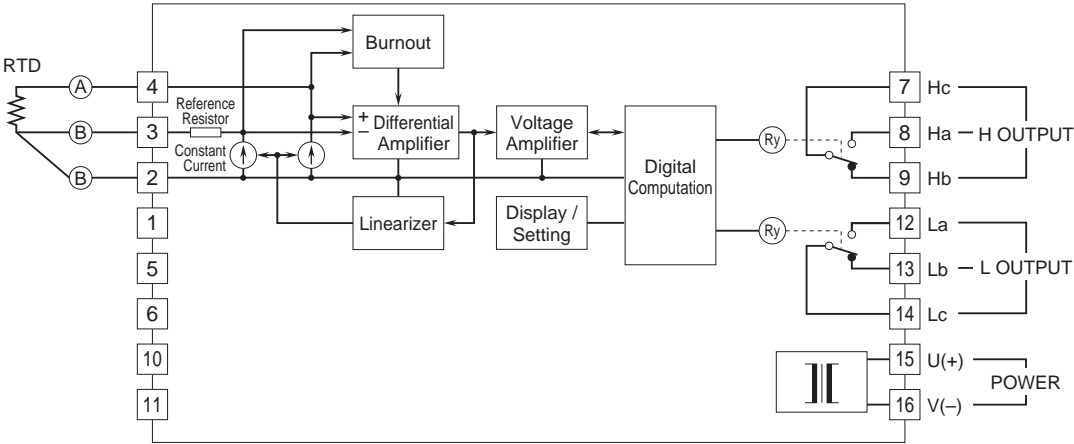

■ ALARM SUFFIX CODE 4: 4 points

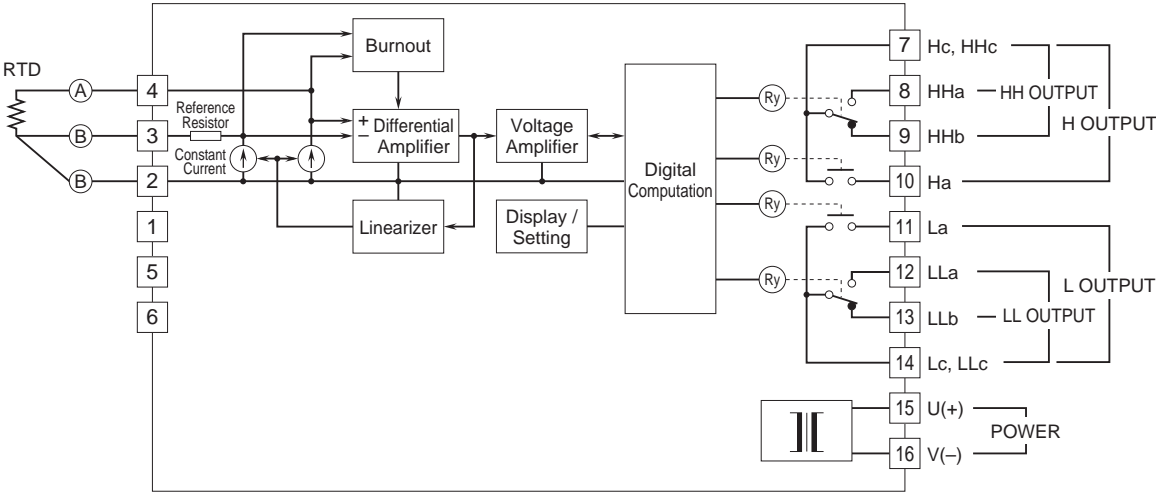

■ Relay Protection

• AC Powered

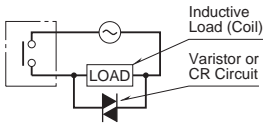

• DC Powered

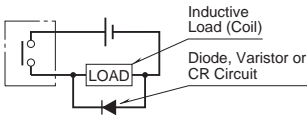

Specifications are subject to change without notice.