

Digital Panel Meters 43 Series

DC INPUT DIGITAL PANEL METER

(process meter)

Functions & Features

- -1999 to +9999 digital panel meter
- Scaling & Hold functions available
- Screwless spring terminal

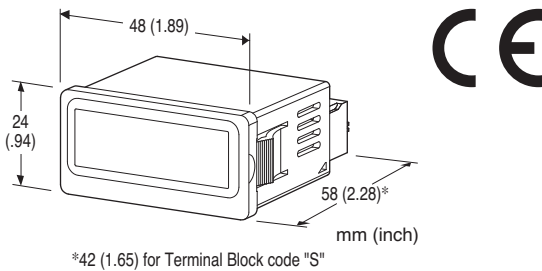

MODEL: 43DV2-[1][2]-R[3]

ORDERING INFORMATION

- Code number: 43DV2-[1][2]-R[3]
- Specify a code from below for each [1] through [3].
(e.g. 43DV2-SAD-R/Q)
- Specify the specification for option code /Q
(e.g. /SET)

[1] INPUT

DC Voltmeter (Without scaled range)

- V1:** ±199.9 mV DC (Conformance range)
(Input range: -219 - +219 mV, Input resistance: ≥1 MΩ)
- V2:** ±1.999 V DC (Conformance range)
(Input range: -2.19 - +2.19 V, Input resistance: ≥1 MΩ)
- V3:** ±19.99 V DC (Conformance range)
(Input range: -21.9 - +21.9 V, Input resistance: ≥1 MΩ)

Process Meter

- S4:** 0 - 10 V DC (Conformance range)
(Input range: -1 - +11 V, Input resistance: ≥1 MΩ)
- S5:** 0 - 5 V DC (Conformance range)
(Input range: 0.5 - 5.5 V, Input resistance: ≥1 MΩ)
- S6:** 1 - 5 V DC (Conformance range)
(Input range: 0.6 - 5.4 V, Input resistance: ≥1 MΩ)
- S0:** Specify voltage (See INPUT SPECIFICATIONS)
- SA:** 4 - 20 mA DC (Conformance range)
(Input range: 2.4 - 21.6 mA, Input resistance: 20 Ω)
- SB:** 0 - 20 mA DC (Conformance range)
(Input range: -2 - +22 mA, Input resistance: 20 Ω)
- SC:** 0 - 10 mA DC (Conformance range)
(Input range: -1 - +11 mA, Input resistance: 40.2 Ω)
- SG:** 0 - 1 mA DC (Conformance range)

(Input range: -0.1 - +1.1 mA, Input resistance: 402 Ω)
SJ: 0 - 5 mA DC (Conformance range)
 (Input range: -0.5 - +5.5 mA, Input resistance: 80.6 Ω)
SZ: Specify current (See INPUT SPECIFICATIONS)

[2] TERMINAL BLOCK

S: Screwless spring terminal
D: Separable screwless spring terminal

POWER INPUT

DC Power
R: 24 V DC
 (Operational voltage range 24 V ±10 %, ripple 10 %p-p max.)

[3] OPTIONS

blank: none
/Q: With options (specify the specification)

SPECIFICATIONS OF OPTION: Q

EX-FACTORY SETTING

/SET: Preset according to the Ordering Information Sheet
 (No. ESU-9422)

GENERAL SPECIFICATIONS

- Construction:** Panel flush mounting
- Connection**
- Terminal block "S":** Screwless spring terminal
 Applicable wire size 1.0 to 1.3 mm², stripped length 9 mm
- Terminal block "D":** Separable screwless spring terminal
 Applicable wire size 1.0 to 1.3 mm², stripped length 8 mm
- Housing material:** Flame-resistant resin (gray)
- Isolation:** Input to power
- A/D conversion:** Σ - Δ
- Sampling rate:** 5 times/sec. (200 msec.)
- Averaging:** None or moving average
- Setting:** (Front button)
- Scaled range (Process meter)
 - Calibration (DC Voltmeter)
 - Moving average
 - Brightness
 - Others

DISPLAY

Display: 4 digits of 10.2 mm (.4") height, 7-segment, red LED

Display range: -1999 to 9999

Zero indication: Higher-digit zeros are suppressed.

- **DC Voltmeter:** 'S.ERR' blinks when out of the input range.
- **Process meter**

Scaling range for measurement range (conformance range):



-1999 to 9999 counts

Decimal point position: 10^{-1} , 10^{-2} , 10^{-3} or none

Over-range indication: '-1999' or '9999' blinks when out of the scaled display range.

'S.ERR' blinks when out of the input range.

Engineering unit indication: Sticker label attached

DC, AC, mV, V, kV, μ A, mA, A, kA, mW, W,

kW, var, kvar, Mvar, VA, Hz, Ω , k Ω , M Ω ,

cm, mm, m, m/sec, mm/min, cm/min, m/min,

m/h, m/s², inch, l, l/s, l/min, l/h, m³, m³/sec,

m³/min, m³/h, Nm³/h, N·m, N/m², g, kg, kg/h,

N, kN, Pa, kPa, MPa, t, t/h, °C, °F, %RH, J,

kJ, MJ, rpm, sec, min, pH, %, ppm, etc.

Scaling Value A) ÷ (default Display Scaling Value B - default Display Scaling Value A) |

Line voltage effect: ±1 digit over voltage range

Insulation resistance: ≥ 100 M Ω with 500 V DC

Dielectric strength: 1000 V AC @1 minute (input to power to ground)

STANDARDS & APPROVALS

CE conformity:

EMC Directive (2004/108/EC)

EMI EN 61000-6-4: 2007/A1: 2011

EMS EN 61000-6-2: 2005

INPUT SPECIFICATIONS

■ DC Current

SZ: Specify current range

Conformance range: 0 - 50 mA DC

Minimum span: 1 mA

Operational range: -10 % - +110 % of input span

Input resistance: 5 - 250 [Ω]*

* Calculated as follows;

Input resistance [Ω] = 250 ÷ Input current at 100 % [mA]

■ DC Voltage

S0: Specify voltage

Input range: 0 - 19.99 V DC

Minimum span: 0.1 V

Operational range: -10 % - +110 % of input span

Input resistance: ≥ 1 M Ω

■ **Hold Input:** Dry contact input

Detecting level: ≤ 0.8 V

Sensing: Approx. 2.1V, 0.03 mA DC

INSTALLATION

Power consumption: Approx. 0.15 W

Operating temperature: -10 to +55°C (14 to 131°F)

Operating humidity: 30 to 90 %RH (non-condensing)

Mounting: Panel flush mounting

Weight: 40 g (1.4 oz)

PERFORMANCE

Accuracy

• **DC Voltmeter:** ±0.1 % rdg ±1 digit

• **Process meter:** ±0.1 % rdg ±1 digit× scaling multiple

(When the scaling-multiple is less than 1, rounded up to 1.)

Temp. coefficient

• **DC Voltmeter:** ±(0.01 % rdg +0.3 digits)/°C

• **Process meter:**

±(0.01 % rdg +0.3 digits× scaling multiple)/°C

(When the scaling-multiple is less than 1, rounded up to 1.)

Scaling-multiple = | (Display Scaling Value B - Display



DISPLAY HOLD COMMAND

Displayed value is held with an external HOLD command input. Connect the contacts across HOLD to COM.

■ WIRING EXAMPLES

(a) 5V-CMOS, TTL

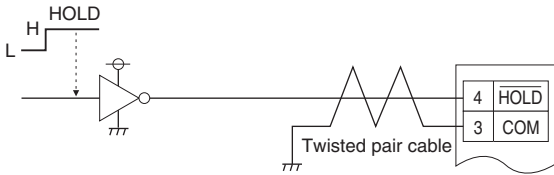

(c) Photo-Coupler

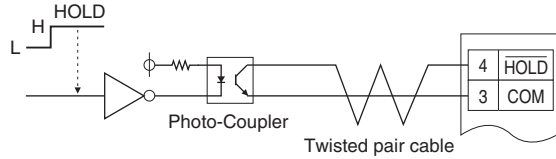

(b) Transistor

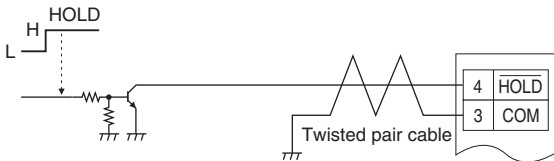

(d) Relay

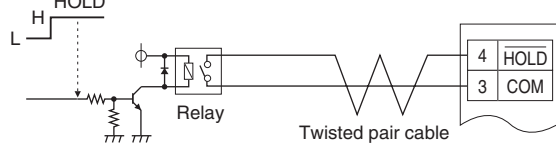

Terminals 3 and 4 are NOT isolated from the internal circuit.

EXTERNAL VIEW

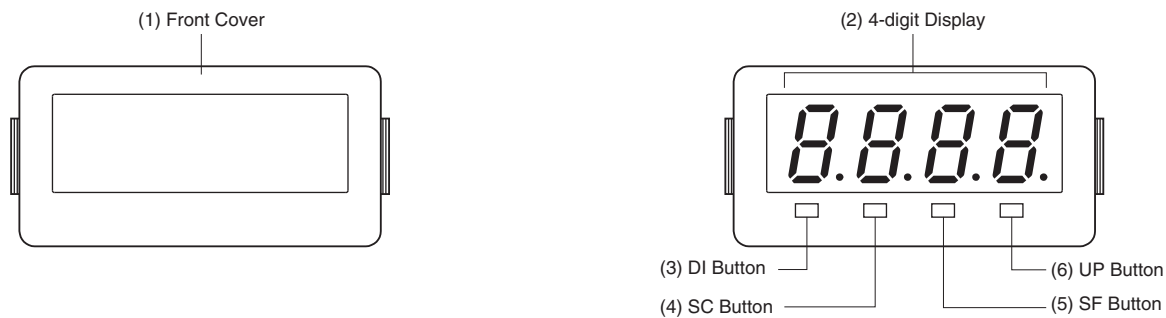

■ COMPONENT IDENTIFICATION

No.	COMPONENT	FUNCTION
(1)	Front Cover	Removed at configuration.
(2)	4-digit Display	4-digit LED display. Range: -1999 to 9999 (not including decimal point)
(3)	DI Button	Used to move on to the display setting mode; or to shift through setting items in each setting mode.
(4)	SC Button	Used to move on to the scaling setting or calibration mode; or to shift through setting items in each setting mode.
(5)	SF Button	Used to move on to the setting standby status and shift through display digits in each setting item.
(6)	UP Button	Used to select setting value.

PARAMETER LIST

■ SCALING SETTING MODE (Process meter, applicable to input code Sx only)

PARAMETER	DISPLAY	FUNCTION	MEASURING RANGE	DEFAULT VALUE
Display Scaling Value A	-9999 ... 9999	Display value for 0% input *1 To distinguish from B, the first decimal point is blinking.	S4	00.00
			S5	00.00
			S6	0.100
			S0	*2
			SA	04.00
			SB	00.00
			SC	00.00
			SG	00.00
			SJ	00.00
			SZ	*2
Display Scaling Value B	-9999 ... 9999	Display value for 100% input *1	S4	10.00
			S5	05.00
			S6	05.00
			S0	*2
			SA	20.00
			SB	20.00
			SC	10.00
			SG	10.00
			SJ	50.00
			SZ	*2
Decimal Point Position	10 ⁻¹ through 10 ⁻³ or none	Decimal point position	S4	88.88
			S5	88.88
			S6	88.88
			S0	*2
			SA	88.88
			SB	88.88
			SC	88.88
			SG	88.88
			SJ	88.88
			SZ	*2

*1. 0% input and 100% input mean the default values according to the input code.

*2. Specified value

• Normal Scaling

The display value increases when the input signal increases.

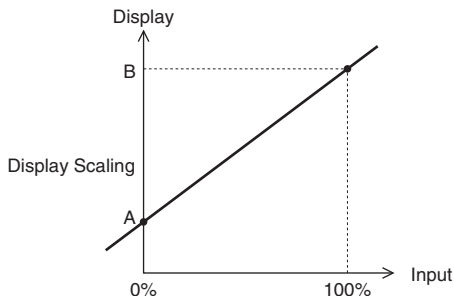

• Inverted Scaling

The display value decreases when the input signal increases.

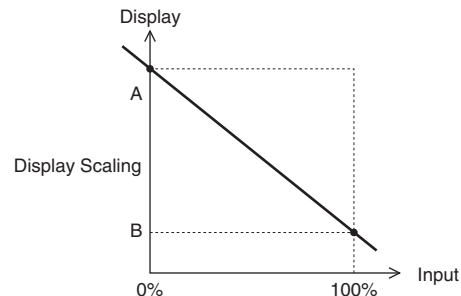

The decimal point position can be set to any digit. Set it according to the 100% value.



■ CALIBRATION MODE (Only for DC Voltmeter, applicable to input code V1, V2, V3)

PARAMETER	DISPLAY	FUNCTION	DEFAULT VALUE
0% Calibration	$\bar{\epsilon} r 0$	Calibrates 0% input	Factory Calibration
50% Calibration	$\bar{n} i d d$	Calibrates 50% input	
100% Calibration	$\bar{S} P A n$	Calibrates 100% input	

■ DISPLAY SETTING MODE

PARAMETER	DISPLAY	FUNCTION	DEFAULT VALUE
Moving Average	$R o F F$	No moving averaging	$R o F F$
	$R 2$	Moving average with 2 samples	
	$R 4$	Moving average with 4 samples	
	$R 8$	Moving average with 8 samples	
Brightness	$[1$	Brightness level 1 (dark)	$[5$
	$[2$	Brightness level 2	
	$[3$	Brightness level 3	
	$[4$	Brightness level 4	
	$[5$	Brightness level 5 (bright)	
Initialization	$r o F F$	Non-initialization	$r o F F$
	$r E S t$	Initialize settings (change to factory settings) *1	
Version Indication	-	Version number, indication only	-

*1. While " $r E S t$ " is shown, pressing DI button or SC button initializes settings.

If "Initialization" is done once, all current parameters will be deleted and overwritten with factory default values. Notice that after this, Ex-factory settings with "/SET" option will be irrecoverable.



DIMENSIONS unit: mm (inch)

■ TOP VIEW

- Separable terminal

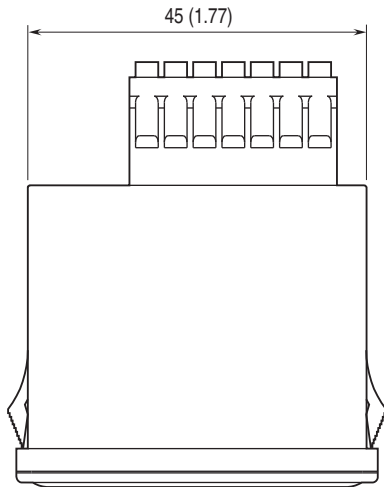

- One block terminal

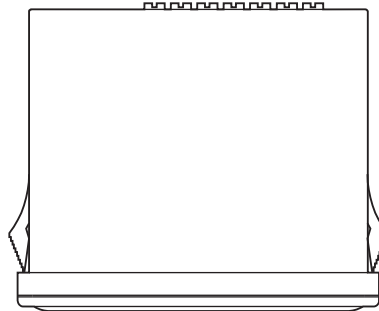

■ FRONT VIEW

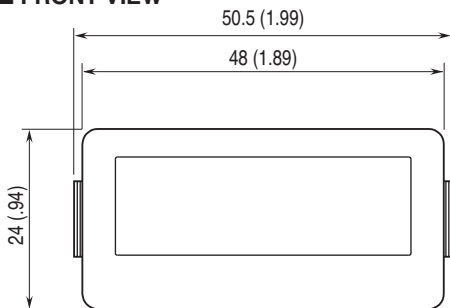

■ SIDE VIEW

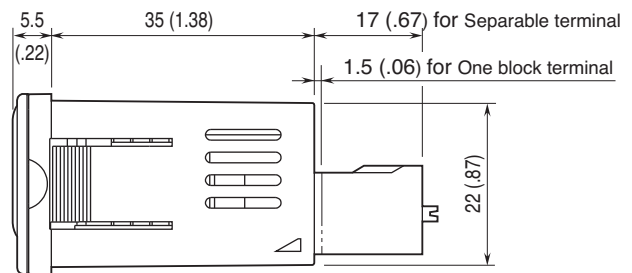

■ REAR VIEW

- Separable terminal

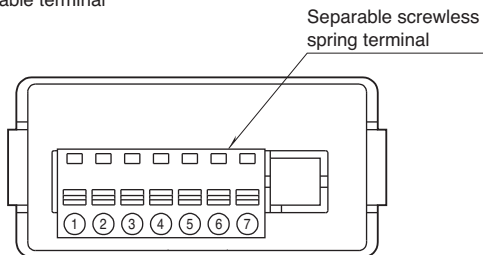

- One block terminal

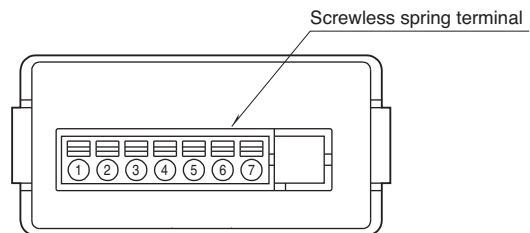

MOUNTING REQUIREMENTS unit: mm

■ PANEL CUTOUT

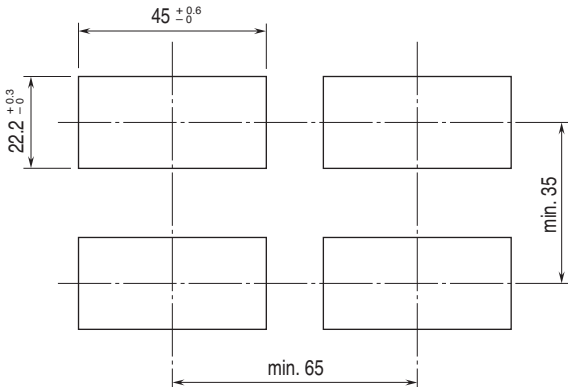

Panel thickness: 0.8 to 3.5 mm

MOUNTING

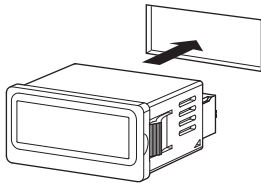

Just insert the meter body (snap-in method)

SCHEMATIC CIRCUITRY & CONNECTION DIAGRAM

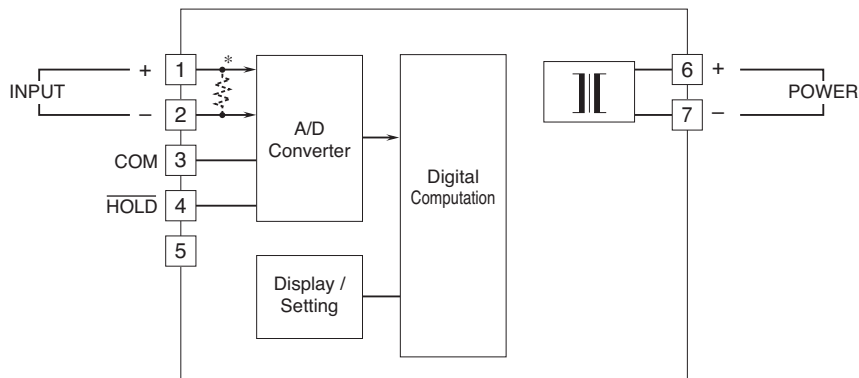

*Input shunt resistor attached for current input.



Specifications are subject to change without notice.