

Digital Panel Meters 43 Series

LOOP POWERED DIGITAL PANEL METER

(process meter)

Functions & Features

- Loop powered -1999 to 9999 compact digital meter
- Scaling function
- Screwless spring terminal

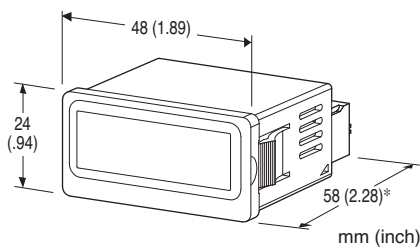

*42 (1.65) for Terminal Block code "S"

MODEL: 43AL1-[1][2]

ORDERING INFORMATION

- Code number: 43AL1-[1][2]
- Specify a code from below for each [1] and [2].
(e.g. 43AL1-D/Q)
- Specify the specification for option code /Q
(e.g. /SET)

INPUT

4 - 20 mA DC

[1] TERMINAL BLOCK

- S: Screwless spring terminal
- D: Separable screwless spring terminal

[2] OPTIONS

- blank: none
- /Q: With options (specify the specification)

SPECIFICATIONS OF OPTION: Q

EX-FACTORY SETTING

/SET: Preset according to the Ordering Information Sheet
(No. ESU-9425)

GENERAL SPECIFICATIONS

Construction: Panel flush mounting

Connection

Terminal block "S": Screwless spring terminal
Applicable wire size 1.0 to 1.3 mm², stripped length 9 mm

Terminal block "D": Separable screwless spring terminal
Applicable wire size 1.0 to 1.3 mm², stripped length 8 mm

Housing material: Flame-resistant resin (gray)

Isolation: Input to FE(Functional Earth)

A/D conversion: $\Sigma - \Delta$

Sampling rate: 10 times/sec. (100 msec.)

Averaging: None or moving average

Setting: (Front button)

- Scaled range
- Moving average

DISPLAY

Display: 4 digits of 10.2 mm (.4") height, 7-segment, red LED

Display range: -1999 to 9999

Scaling range for measurement range: -1999 to 9999 counts

Decimal point position: 10⁻¹, 10⁻², 10⁻³ or none

Zero indication: Higher-digit zeros are suppressed.

Over-range indication: '-1999' or '9999' flashing for display values out of the scaled range. 'S.ERR' blinks surpassing the permissible range.

Engineering unit indication: Sticker label attached

DC, AC, mV, V, kV, μ A, mA, A, kA, mW, W, kW, var, kvar, Mvar, VA, Hz, Ω , k Ω , M Ω , cm, mm, m, m/sec, mm/min, cm/min, m/min, m/h, m/s², inch, l, l/s, l/min, l/h, m³, m³/sec, m³/min, m³/h, Nm³/h, N·m, N/m², g, kg, kg/h, N, kN, Pa, kPa, MPa, t, t/h, °C, °F, %RH, J, kJ, MJ, rpm, sec, min, pH, %, ppm, etc.

INPUT SPECIFICATIONS

■ DC Current

Current range: 3.75 to 22 mA DC

Voltage drop: Approx. 3.5 V with 4 mA; approx. 3.7 V with 20 mA (Equivalent input impedance: Approx. 185 Ω)
(Use of the unit causes voltage drop. For 2-wire transmitter, be sure that the voltage by which 2-wire transmitter can operate is ensured including the voltage drop by other devices and wiring resistance.)

INSTALLATION

Operating temperature: -10 to +55°C (14 to 131°F)

Operating humidity: 30 to 90 %RH (non-condensing)

Mounting: Panel flush mounting

Weight: 30 g (1.1 oz)

PERFORMANCE

Accuracy: ± 0.1 % rdg ± 1 digit \times scaling multiple

(When the scaling-multiple is less than 1, rounded up to 1.)



Temp. coefficient: $\pm 0.3 \text{ digits} \times \text{scaling multiple}/^\circ\text{C}$
 (When the scaling-multiple is less than 1, rounded up to 1.)
 Scaling-multiple = $|(\text{Display Scaling Value B} - \text{Display Scaling Value A}) \div (\text{default Display Scaling Value B} - \text{default Display Scaling Value A})|$
Insulation resistance: $\geq 100 \text{ M}\Omega$ with 500 V DC
Dielectric strength: 500 V AC @1 minute (input to FE)

STANDARDS & APPROVALS

CE conformity:
 EMC Directive (2004/108/EC)
 EMI EN 61000-6-4: 2007/A1: 2011
 EMS EN 61000-6-2: 2005

EXTERNAL VIEW

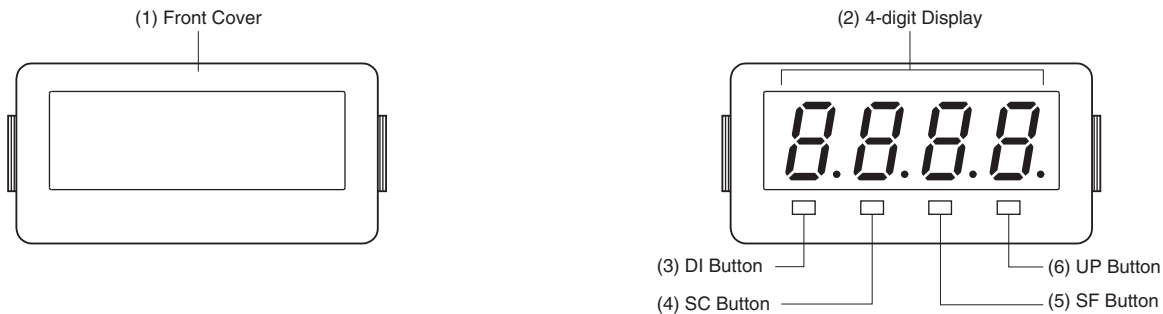

COMPONENT IDENTIFICATION

No.	COMPONENT	FUNCTIONS
(1)	Front Cover	Removed at configuration.
(2)	4-digit Display	4-digit LED display. Range: -1999 to 9999 (not including decimal point)
(3)	DI Button	Used to move on to the display setting modes; or to shift through setting items in each setting mode.
(4)	SC Button	Used to move on to the scaling setting modes; or to shift through setting items in each setting mode.
(5)	SF Button	Used to move on to the setting standby status and shift through display digits in each setting item.
(6)	UP Button	Used to select setting value.

PARAMETER LIST

SCALING SETTING MODE

PARAMETER	DISPLAY	FUNCTION	DEFAULT VALUE
Display Scaling Value A	<i>-9999 ... 9999</i>	Display value for 4mA input To distinguish from B, the first decimal point is blinking.	<i>0400</i>
Display Scaling Value B	<i>-9999 ... 9999</i>	Display value for 20mA input	<i>2000</i>
Decimal Point Position	10^{-1} through 10^{-3} or none	Decimal point position	<i>8888</i>



- Normal Scaling
The display value increases when the input signal increases.

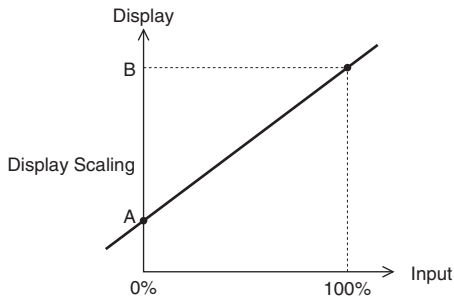

- Inverted Scaling
The display value decreases when the input signal increases.

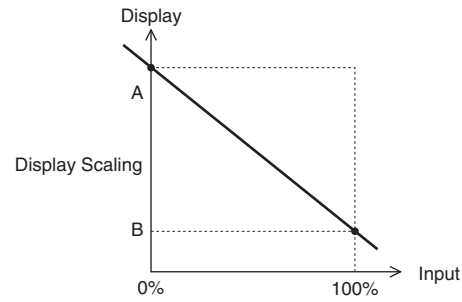

The decimal point position can be set to any digit. Set it according to the 100% value.

■ DISPLAY SETTING MODE

PARAMETER	DISPLAY	FUNCTION	DEFAULT VALUE
Moving Average	RoFF	No moving averaging	RoFF
	R 2	Moving average with 2 samples	
	R 4	Moving average with 4 samples	
	R 8	Moving average with 8 samples	
Initialization	r oFF	Non-initialization	r oFF
	r ESt	Initialize settings (change to factory settings) *1	
Version Indication	-	Version number, indication only	-

*1. While "r ESt" is shown, pressing DI button or SC button initializes settings.

If "Initialization" is done once, all current parameters will be deleted and overwritten with factory default values. Notice that after this, Ex-factory settings with "SET" option will be irrecoverable.



DIMENSIONS unit: mm (inch)

■TOP VIEW

- Separable terminal

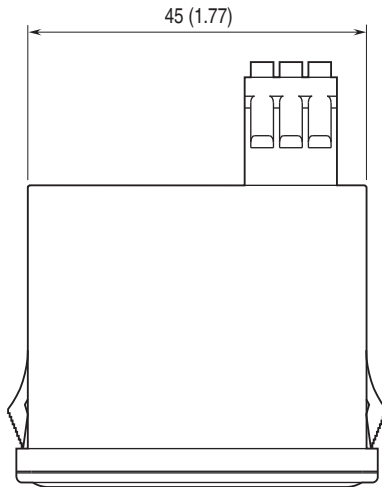

- One block terminal

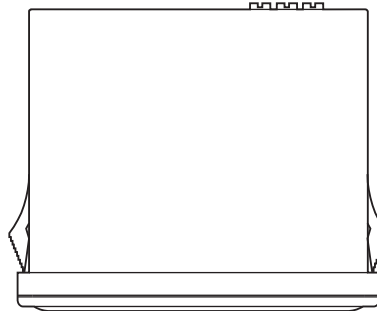

■FRONT VIEW

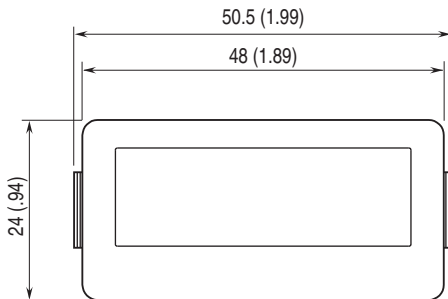

■SIDE VIEW

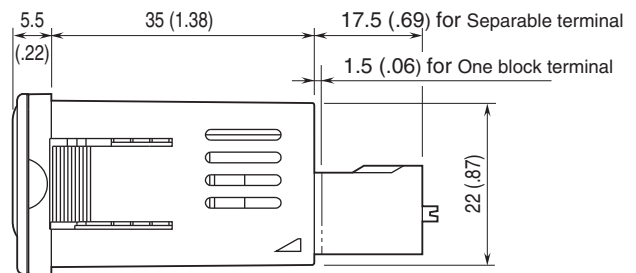

■REAR VIEW

- Separable terminal

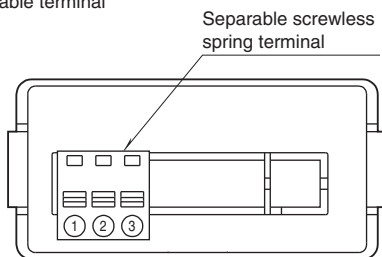

- One block terminal

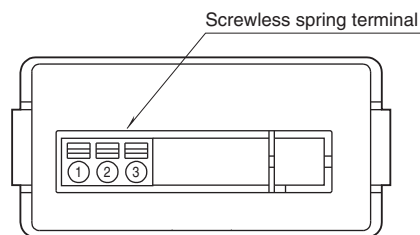

MOUNTING REQUIREMENTS unit: mm

■ PANEL CUTOUT

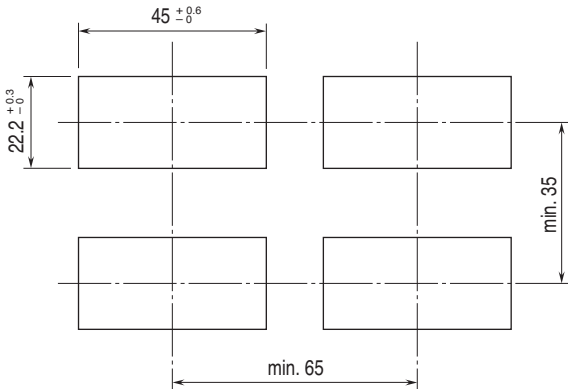

Panel thickness: 0.8 to 3.5 mm

MOUNTING

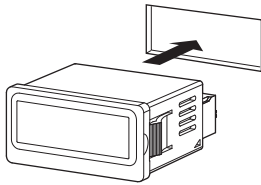

Just insert the meter body (snap-in method)

SCHEMATIC CIRCUITRY & CONNECTION DIAGRAM

Note: In order to improve EMC performance, bond the FE terminal to ground.

Caution: FE terminal is NOT a protective conductor terminal.

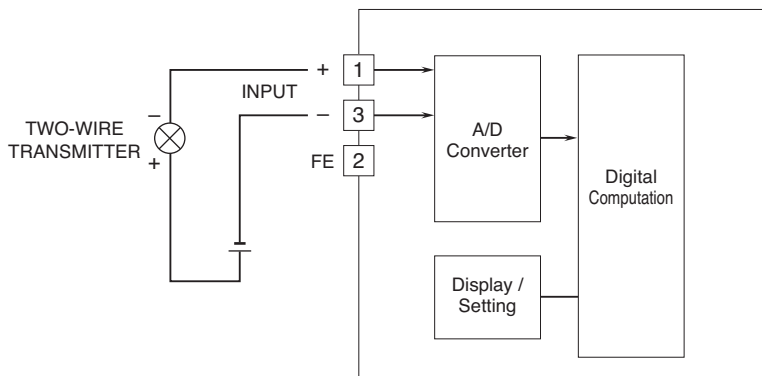

Specifications are subject to change without notice.