

Lightning Surge Protectors for Electronics Equipment M-RESTER

LIGHTNING SURGE PROTECTOR FOR RS-485 / RS-422

Functions & Features

- Designed specifically for the network
- No interruption of transmission signal by unplugging the head element module

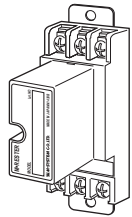

MODEL: MDP-4R[1]

ORDERING INFORMATION

- Code number: MDP-4R[1]
Specify a code from below for [1].
(e.g. MDP-4R/A33)

[1] OPTIONS

DIN Rail Mounting Adapter

blank: Without

/A33: With adapter (model A-33)

GENERAL SPECIFICATIONS

Construction: Plug-in

Connection: M4 screw terminals (torque 0.8 N·m)

Screw terminal: Nickel-plated steel

Housing material: Flame-resistant resin (black)

INSTALLATION

Operating temperature: -5 to +55°C (23 to 131°F)

Operating humidity: 30 to 90 %RH (non-condensing)

Mounting: Surface or DIN rail

Weight: 100 g (0.22 lb), standard; 125 g (0.28 lb), with DIN rail mounting adapter

PERFORMANCE

Max. continuous operating voltage (Uc):

B to C: ±5 V min

B or C to A: 5 V min

Line to earth: ±140 V min

Voltage protection level (Up):

• @ 2 kV (1 kA)

2 to 3: ±20 V max.

2 or 3 to 1: 20 V max.

Line to earth: ±500 V max.

Response time:

Line to line: ≤ 4 nsec.

Line to earth: ≤ 20 nsec.

Leakage current:

B to C: ≤ 0.2 mA @ ±5 V DC

B or C to A: ≤ 0.2 mA @ 5 V DC

Line to earth: ≤ 10 µA @ ±140 V DC

Max. discharge current (Imax): 5000 A (8 / 20 µs)

Nominal current (In): 100 mA

Internal series resistance: Approx. 4.5 Ω including return

Capacitance @ 1 MHz:

Line to line: ≤ 1000 pF

Line to earth: ≤ 100 pF

Input attenuation: -0.5 dB or less @ DC to 2.0 MHz, Zo = 110 Ω

STANDARDS & APPROVALS

Surge protection: IEC 61643-21: 2000

(Categories C1, C2)



CONNECTION EXAMPLES

Example: Protected devices have no **SG** terminals

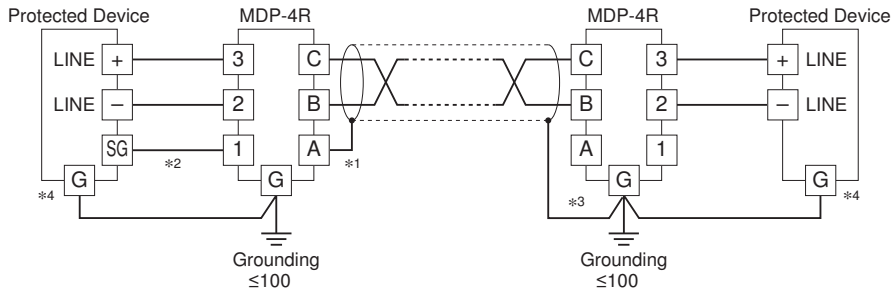

- *1. Leave Terminal **A** when the shielded twisted-pair cable is not provided.
- *2. Leave Terminal **1** when the protected device has no **SG** (Signal Ground) terminal.
- *3. Cross wire to the surge protector's **G** terminal when grounding the shield wire.
- *4. Cross-over wire between **G** terminals of the surge protector and the protected device is required. Ground only the surge protector if the protected device has no **G** terminal.

Example: Each **SG** terminal is connected with triplex cable

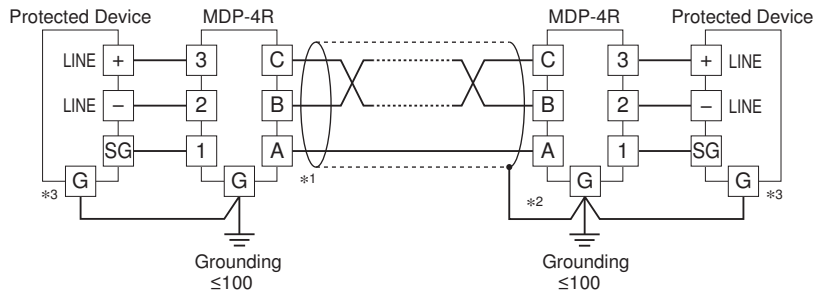

- *1. Provide electrical insulation with insulating tape and the like so that the live part is not exposed, as over voltage may generate on the shield wire.
- *2. Cross wire to the surge protector's **G** terminal when grounding the shield wire.
- *3. Cross-over wire between **G** terminals of the surge protector and the protected device is required. Ground only the surge protector if the protected device has no **G** terminal.

GROUNDING

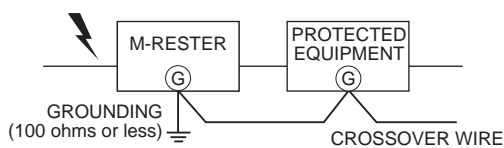

A crossover wire between M-RESTER ground and the ground or metallic housing of the equipment is required for protection. If the protected equipment has no ground terminal, ground the M-RESTER only. When the M-RESTER is mounted with DIN Rail Mounting Adapter, connect the grounding wire to the mounting screw of the M-RESTER.

EXTERNAL DIMENSIONS & TERMINAL ASSIGNMENTS unit: mm (inch)

■ STANDARD

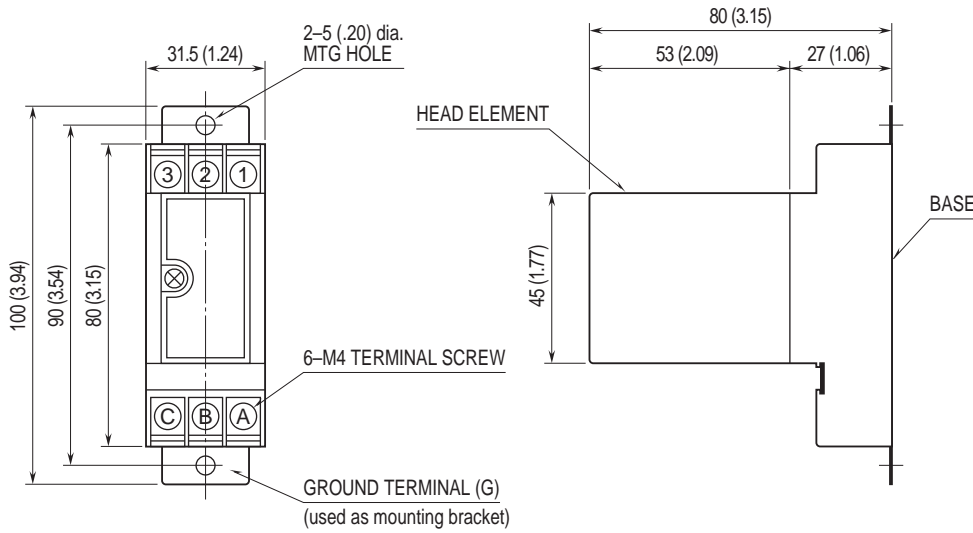

■ WITH DIN RAIL MOUNTING ADAPTER

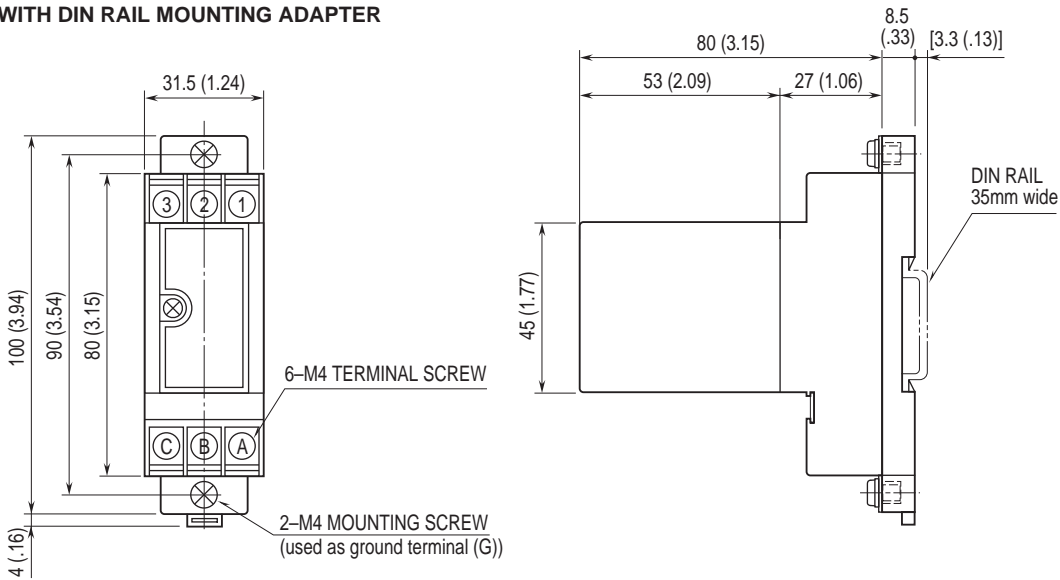

MOUNTING REQUIREMENTS unit: mm (inch)

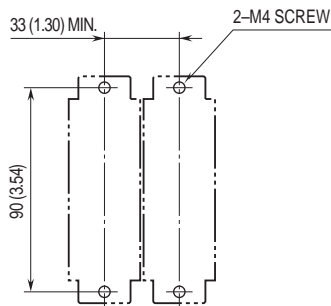

SCHEMATIC CIRCUITRY & CONNECTION DIAGRAM

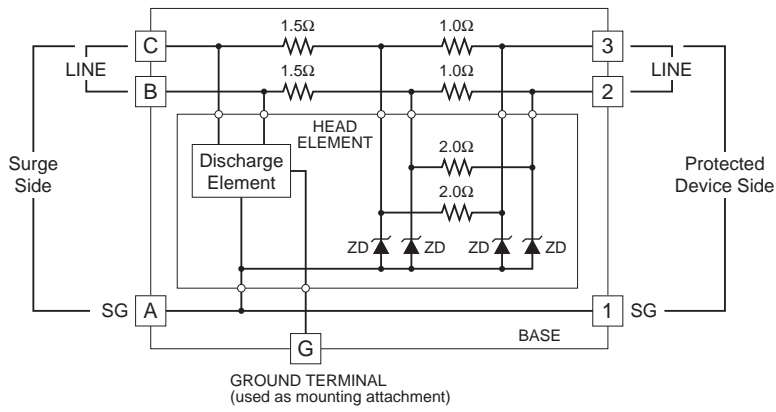

Specifications are subject to change without notice.

